

**CONSULTATION PAPER ON A
PROPOSED OPERATIONAL MODEL FOR A
SCRIPLESS SECURITIES MARKET**

October 2003



Hong Kong Exchanges and Clearing Limited

TABLE OF CONTENTS

		<i>Page No.</i>
Executive Summary		i - viii
Chapter One	Background	1-4
Chapter Two	Current CCASS Operation	5-8
Chapter Three	Proposed Operational Model for a Scripless Securities Market	9-33
Chapter Four	CCASS Dematerialisation Programme	34-35
Chapter Five	Services to Shareholders	36-39
Chapter Six	Initial Public Offerings	40-42
Chapter Seven	Implications of the Scripless Securities Market Model for Market Operations	43-48
Chapter Eight	Other Issues	49-51
Chapter Nine	Conclusions	52-54
Glossary of Terms		55-62
List of Diagrams		63
Appendix 1	HKEx Statements of Policy on Personal Data	64-65
Appendix 2	Reconciliation of the Record of Inter-register Transfers	66
Appendix 3A	An Overview of Post-scripless CCASS Transaction Types	67
Appendix 3B	An Overview of Post-scripless Share Registrar Transaction Types	68
Appendix 3C	An Overview of Post-scripless Transaction Types between CCASS and Share Registrars	69
Appendix 4	CCASS Processing Schedule under the Scripless Securities Market Model	70
Appendix 5	Day-end Interactions between CCASS and Share Registrars' Systems	71
Appendix 6	Summary of the Major Changes to the IPO Process (for Yellow Application Form and CCASS EIPO) under the Scripless Securities Market Model	72-73

EXECUTIVE SUMMARY

The Hong Kong Exchanges and Clearing Limited (“HKEx”) is publishing a Consultation Paper on a Proposed Operational Model for a Scripless Securities Market (“this Consultation Paper”) to invite market inputs and comments.

In February 2002, the Securities and Futures Commission (“SFC”) issued a Consultation Paper on Proposals for a Scripless Securities Market¹ (“SFC Consultation Paper”) to consult the market on proposals for a scripless securities market. In late September this year, the SFC published its Consultation Conclusions on Proposals for a Scripless Securities Market (“SFC Consultation Conclusions”) to indicate a preference for a split register model as proposed in the SFC Consultation Paper. The key proposals put forth in the SFC Consultation Paper and confirmed in the SFC Consultation Conclusions include –

- the removal of the legal requirement for listed companies incorporated in Hong Kong to issue certificates to their shareholders;
- a Central Clearing and Settlement System (“CCASS”) Register to be maintained by the Hong Kong Securities Clearing Company Limited (“HKSCC”) for registering the shareholdings of the CCASS Participants deposited into the CCASS Depository;
- an Issuer Register to be maintained by the issuer (or its appointed share registrar) for registering the uncertificated shareholdings outside of the CCASS Depository and all certificated shareholdings;
- a complete register of members of an issuer comprising both the CCASS Register and the Issuer Register. The two registers will not overlap; and
- an infrastructure enabling transfers of uncertificated shares between the CCASS Register and the Issuer Register.

Following the publication of the SFC Consultation Paper, a Scripless Implementation Working Group (“IWG”) was formed by the SFC to develop an operational model and implementation plan for a scripless securities market. A Scripless Model Technical Working Group (“TWG”) and three

¹ <http://www.hksfc.org.hk>

focus groups were also formed. Their membership included the Federation of Share Registrars, brokers, custodians, issuers and HKEx. In developing the operational model proposed in this Consultation Paper, HKEx has made reference to the work done by those bodies, in particular the TWG. The proposed operational model is mainly based on the proposals contained in the SFC Consultation Paper. This Consultation Paper should be directly relevant to CCASS Participants, issuers, share registrars, other market intermediaries and the investing public.

This Consultation Paper focuses mainly on the details and key issues of the operational model for a scripless securities market. It also highlights the security issues relating to the handling of uncertificated shares, especially transfers from the Issuer Register to the CCASS Register (for example for trade settlement) and discusses certain risk issues relating to deposits of physical scrip into the CCASS Depository. While it also briefly touches upon legal issues, we expect that they will be discussed more thoroughly under the IWG and the various focus groups led by the SFC.

In devising the operational model, HKEx has attached substantial importance to the following principles and objectives –

- the model should maintain the current choices provided to investors, including the choice to register their shareholdings either directly in their own names or through market intermediaries and financial services providers such as brokers and custodians;
- the model should enhance market efficiency and thereby reduce costs;
- the model should facilitate fair allocation of costs through the user-pays principle;
- the model should improve protection to investors and reduce the risk of misappropriation; and
- the model should uphold current market integrity and system reliability levels.

Chapter Two summarises the current CCASS operation. At present, Hong Kong's securities market is still paper-based. Companies incorporated in Hong Kong are required under the law to issue physical certificates to their

shareholders. HKSCC, a wholly owned subsidiary of HKEx, operates CCASS on the basis of immobilisation² where shares deposited by its Participants are re-registered in the name of the HKSCC Nominees Limited (“HKSCC Nominees”) and securities settlement is effected by way of electronic book entries in CCASS. The CCASS Depository maintains a physical vault for the safekeeping of the scrip on deposit.

Chapter Three describes the proposed operational model for a scripless securities market. According to the SFC Consultation Conclusions, there will be a new account type on the CCASS Register called the CCASS Participant Sponsored Account. The concept stems from the existing Stock Segregated Account with Statement Service in CCASS. Holders of the CCASS Participant Sponsored Accounts will have to be sponsored by CCASS Participants (other than Investor Participants). Shares deposited into the CCASS Participant Sponsored Accounts will be registered directly in the names of the holders of these accounts but the sponsoring CCASS Participants will have full control over the operation of the CCASS Participant Sponsored Accounts.

We also propose adding a new category of CCASS Participant – Registrar Participant. Registrar Participantship, as the name suggests, is open only to Approved Share Registrars. For the implementation of a scripless securities market, a mechanism is needed to facilitate future technical development relating to the scripless market infrastructure with the share registrars and establish the applicable electronic linkages with them. One way to achieve this is through CCASS participantship. Registrar participantship will enable HKSCC and the share registrars, through the CCASS Rules and Operational Procedures, to define and enforce the technical and operational requirements of the scripless securities market environment. We are open to suggestions from the market, especially from the Federation of Share Registrars, on other feasible ways to achieve the above objectives. As a related but separate issue, for those share registrars that are not prepared or cannot afford to invest in systems that enable them to participate in a scripless securities market and link up with CCASS, consideration could be given to providing them with the option to deal with scrip under the current arrangements, while leaving all the uncertificated shareholdings to CCASS.

² Immobilisation means the holding of certificates in a vault in order to eliminate physical delivery for the purpose of settlement of transactions. In the case of CCASS, certificates with signed transfer forms attached are deposited by Participants with HKSCC and are reflected in the Participants’ CCASS stock accounts to facilitate book-entry settlement (by debit and credit entries to the relevant stock accounts).

The CCASS Depository will be dematerialised (shares on deposit will be converted from physical scrip to uncertificated shares) gradually. Dematerialised shares will be registered directly in the names of the CCASS Participants or the holders of the CCASS Participant Sponsored Accounts on the CCASS Register, rather than in the name of HKSCC Nominees as at present. The CCASS Register will encompass all shareholdings deposited into the CCASS Depository. HKSCC will be subject to legislation defining in the CCASS Rules and Operational Procedures which types of accounts will be of a “name-on-register” nature.

The CCASS Depository will continue to accept deposits of physical certificates which will be dematerialised automatically. For technical and risk management reasons, it is proposed that immediate credit³ of physical deposits will no longer be provided to CCASS Participants after implementation of the scripless securities market model. Since the CCASS Depository will no longer be holding certificates, shares deposited into CCASS can only be withdrawn in electronic form by transferring them to the Issuer Register.

Under the proposed model, physical scrip when deposited into the CCASS Depository will become dematerialised. Such scrip may also be dematerialised directly at the share registrars. Shares dematerialised at the share registrars will be registered on the Issuer Register.

Current settlement services provided by HKSCC in CCASS to its Participants will remain unchanged, except that some of the settlement transactions will, in a scripless environment, result in a change of legal title at the CCASS Participant level on the CCASS Register. Settlement and changes of legal title will take place simultaneously. To better ensure the continued integrity of the process, HKSCC will define in the CCASS Rules “finality” in relation to securities settlement, with legislation to enforce the Rules if necessary. For the avoidance of doubt, it should be noted that registration of shares after settlement of the Stock Exchange of Hong Kong Limited (“SEHK”) Trades at the beneficial owner level will continue to be optional depending on the wishes of the investors concerned.

³ Subject to security control vetting measures and HKSCC’s right to reject a deposit, Eligible Securities deposited by a Participant other than an Investor Participant will normally be immediately credited to that Participant’s stock account. Eligible Securities deposited by an Investor Participant will not be credited to that Participant’s stock account until re-registration in the name of the HKSCC Nominees has been completed and new share certificates are received from the relevant share registrar. During the re-registration period, these Eligible Securities may not be withdrawn or transferred to the stock accounts of other Participants.

Based on the proposal from the Federation of Share Registrars to use Shareholder Reference Numbers (“SRNs”) for uncertificated shareholdings registered on the Issuer Register, HKEx will add new transaction types to support electronic transfers of uncertificated shares between the CCASS Register and the Issuer Registers. Transfers of uncertificated shares into and from the CCASS Register will be equivalent to electronic deposits and withdrawals of shares into and out of the CCASS Depository. Some security issues relating to the transfers of uncertificated shares by shareholders to the CCASS Register however require further discussion among the SFC, the Federation of Share Registrars, market participants and HKEx.

According to the SFC Consultation Paper, rematerialisation (converting uncertificated shares into physical scrip) will be allowed, though not encouraged, after the implementation of a scripless securities market. Rematerialisation requests may be submitted to HKSCC for shares registered on the CCASS Register and to the share registrars for shares registered on the Issuer Register. In both cases, physical scrip will be issued by share registrars. Rematerialised shares will be registered on the Issuer Register.

At day end, HKSCC will copy the CCASS Register to the share registrars who will then produce the complete registers of members on the basis of the CCASS Register and the Issuer Register. This process will require reconciliation by HKSCC and the share registrars to make sure that inter-register transfers and other processes such as distribution of bonus shares, share consolidation and stock splits are properly recorded on both registers. The share registrars will create the complete registers of members available for public inspection as at present, thus obviating the need for the CCASS Register to be open directly to public inspection at the premises of HKSCC.

Chapter Four covers the proposed dematerialisation programme for the CCASS Depository. The dematerialisation of the CCASS Depository will be phased in over a period of approximately six to twelve months. The major advantage of this approach is that it can gradually prepare the market and its users for a scripless environment. HKSCC will co-ordinate closely with the share registrars on the implementation of the CCASS dematerialisation programme.

Chapter Five discusses services to the shareholders, including corporate communication services and corporate action services, to be provided by HKSCC and the share registrars in a scripless environment. It is proposed that share registrars will continue to send corporate communications to all registered shareholders on the registers of members. To maintain its current level of service to the market, it is proposed that HKSCC will continue to provide corporate action services to CCASS Participants in respect of their shareholdings registered on the CCASS Register. Shareholders registered on the Issuer Registers will continue to be served by the share registrars.

Chapter Six provides the implications of a scripless securities market on the Initial Public Offering (“IPO”) process. The IPO process is expected to remain largely unchanged upon implementation of the scripless securities market model. However, with the introduction of uncertificated shares which will not require the capturing of shareholder signatures by share registrars, the eIPO option may become more cost-effective and appealing.

Whilst the SFC Consultation Paper discussed the objectives for and the benefits of a scripless securities market in detail, this Consultation Paper only focuses on the main implications of the proposed scripless securities market model for market operations, and these implications are summarised in Chapter Seven. Implementation of the proposed scripless securities market model will result in certain operational implications for the market and the various market operators and user groups. Of these, it is anticipated that share registrars and HKSCC will be most profoundly affected. The impact on market intermediaries including brokers and custodians should be relatively minor.

Chapter Eight raises three particular issues relating to the scripless securities market model which we believe deserve additional market discussion and further consideration by all market participants including the investing public.

The Federation of Share Registrars proposed that a unique SRN be assigned to each of the uncertificated shareholdings registered on the Issuer Registers. The SRN will be generated and managed by the share registrars. SRN is a matter between the share registrars and the shareholders registered on the Issuer Registers and is not a feature of the CCASS infrastructure per se. Unintended disclosure of SRNs may expose the shareholders to a variety of risks including misappropriation of their shares. It would be in the interests

of the market and the investing public that the application of SRNs be the subject of further discussion. Investor education will also be important to ensure that investors fully understand the importance of properly protecting their SRNs.

Certain costs are likely to be incurred by HKSCC, share registrars, market intermediaries and issuers during the dematerialisation process. Further discussion among HKEx, share registrars, issuers, market intermediaries and the SFC will be necessary to consider how the costs of dematerialisation could be borne in a fair and reasonable manner.

The implementation of a scripless securities market will inevitably affect the operation and business model of HKSCC as well as other market participants. This may lead to changes in the fee structures of these entities. Although beyond the scope of this Consultation Paper, we believe the issue of fees will be dealt with through the normal operation of market forces and the established processes.

Chapter Nine, the last chapter of this Consultation Paper, provides a conclusion of the proposals and highlights issues for comments. Chapter Nine is followed by a Glossary of Terms and a List of Diagrams.

For convenience and simplicity sake, discussion in this Consultation Paper will be limited to the subject of “shares”. However, according to the SFC Consultation Paper, the new legislation would apply to “securities” to be defined broadly as the term is defined in the Securities and Futures Ordinance. This would enable the scripless regulations to cover not only shares and debentures, but other listed products such as warrants and exchange-traded funds. Should such other forms of securities be included in the scope of scripless legislation, the proposals made in this Consultation Paper would also be applicable to them.

Finally, the implementation of the scripless securities market model is subject to legislative amendments, which are being worked on by the Government and the SFC and, as noted in the SFC Consultation Conclusions, will be the subject of a separate consultation. HKEx will provide its input to the Government and the SFC.

We welcome comments on this Consultation Paper. Comments should be made in writing before close of business on Tuesday, 23 December 2003 by:

- (i) mail to: Hong Kong Exchanges and Clearing Limited
7th Floor, Vicwood Plaza
199 Des Voeux Road Central
Hong Kong
Attention: The Scripless Project Team
- (ii) fax to: (852) 2541 3234
- (iii) e-mail to: scp@hkex.com.hk

Further copies of this Consultation Paper may be obtained from HKEx's office at 2nd Floor, Vicwood Plaza, 199 Des Voeux Road Central, Hong Kong. It may also be viewed and downloaded from the HKEx website at <http://www.hkex.com.hk>.

Persons submitting comments to HKEx should give details of any organisation whose views they represent. The names of persons who submit comments on this Consultation Paper together with the whole or part of their submissions may be disclosed to members of the public. Statements of HKEx's policy on handling personal data are set out in Appendix 1.

We would like to take this opportunity to thank the SFC, the Federation of Share Registrars and other market intermediaries for their contribution to the design of the operation of the scripless securities market model. In devising the proposals contained in this paper, all reasonable efforts have been made by HKEx to incorporate their views and suggestions to the extent possible. Their further comments would be most welcome and appreciated.

CHAPTER ONE

BACKGROUND

- 1.1 Discussion of a scripless securities market in Hong Kong dates back as far as the late 1980s when the issue was considered in the Report of the Securities Review Committee on the Operation and Regulation of the Hong Kong Securities Industry published in May 1988⁴. That Report proposed two possible models to achieve book-entry transfer and settlement, namely a depository company approach and an uncertificated system. While the Hong Kong Securities Clearing Company Limited (“HKSCC”) subsequently adopted the depository company approach after thorough consultation with the market, it is its long term goal to establish “*a dematerialised system where securities will no longer be represented by certificates*”⁵.
- 1.2 In the late 1990s, the Government set out its vision of implementing a scripless securities market in Hong Kong. That vision was subsequently included in the Report of the Steering Committee on the Enhancement of the Financial Infrastructure (“SCEFI”) published in 1999 as one of its recommendations to enhance the financial market infrastructure of Hong Kong. The SCEFI Report specifically recommended that Hong Kong move towards a secure, scripless market to improve efficiency and reduce risks. In February 2002, the Securities and Futures Commission (“SFC”) published a Consultation Paper on Proposals for a Scripless Securities Market (“SFC Consultation Paper”) to consult the market on proposals for a scripless securities market. In late September 2003, the SFC published its Consultation Conclusions on Proposals for a Scripless Securities Market (“SFC Consultation Conclusions”).
- 1.3 The SFC Consultation Conclusions indicated a preference for a split register scripless model as proposed in the SFC Consultation Paper. Under that model, a complete register of members will comprise two parts – a register maintained by HKSCC (“CCASS Register”) and a

⁴ The Securities Review Committee, chaired by Mr Ian Hay Davison, was appointed on 16 November 1987 by the then Governor of Hong Kong to review the constitution, powers, management and operation of the then Hong Kong Stock and Futures Exchanges and their respective regulatory bodies.

⁵ The Consultative Paper on Business Operations and System Design of the Central Clearing and Settlement System (CCASS) published by the Hong Kong Securities Clearing Company Limited in 1991, p.6.

register maintained by issuers or their appointed share registrars (“Issuer Register”). The two registers will not overlap.

- 1.4 Following the SFC Consultation Paper, a Scripless Implementation Working Group (“IWG”), comprising representatives of the Government, the SFC, HKEx, share registrars, and other market participants, was formed to further develop a scripless model and implementation plan. The operational model and the implementation plan proposed in this Consultation Paper is largely a result of the various discussions of the IWG. The proposed operational model is mainly based upon the proposals contained in the SFC Consultation Paper and the SFC Consultation Conclusions, envisaging that both the CCASS Register and the Issuer Register will be recognised by law as the legal registers of members. We encourage readers of this paper to study this paper in conjunction with the SFC Consultation Paper and the SFC Consultation Conclusions. In developing the operational model, HKEx has taken into account the characteristics of the securities market in Hong Kong and the current market infrastructure and operational model with a view to preserving market flexibilities and investor choices as far as possible and to attaining maximum efficiency and cost-effectiveness of the future scripless securities market model.

Current Securities Market Structure

- 1.5 Hong Kong’s securities market is at present paper-based. Companies incorporated in Hong Kong are required under the Companies Ordinance (Cap. 32) to issue physical certificates to their shareholders and to keep a register of members. Issuers are required under the Rules Governing the Listing of Securities on the Stock Exchange of Hong Kong Limited (“SEHK”) to appoint an Approved Share Registrar to maintain a register of members in Hong Kong. It is prescribed that transfers of shares (registered ownership) must be done in the form of a proper instrument of transfer, physically delivered to the share registrar together with the relevant share certificates before the transfer of those shares can be registered.
- 1.6 It is estimated that there are a total of two million registered shareholders in Hong Kong holding about 25 million to 30 million share certificates. However, many investors are holding their shares through nominee companies including the HKSCC Nominees Limited (“HKSCC Nominees”) and custodian nominees.

- 1.7 HKSCC is the clearing house for SEHK Trades. Its operation is built upon its Depository, which operates on the basis of immobilisation. It holds certificates in its vault in order to eliminate physical delivery for the purpose of settlement of transactions. Subsequent transfers can therefore be made by book entry, that is, by debits from and credits to the holders' accounts in the CCASS Depository. CCASS Participants deposit their or their clients' shares in physical form into the CCASS Depository. These shares are then re-registered in the name of HKSCC Nominees and in turn HKSCC credits these shares to the accounts of the depositing Participants. Trades are then settled on a continuous netting basis electronically in CCASS by way of electronic debits and credits to the stock accounts of the selling and buying CCASS Participants respectively.
- 1.8 Shares deposited into the CCASS Depository have increased gradually over the years and have now stabilised at approximately 31% of all the issued shares by value and 56% by issued shares, for a total value of approximately HK\$1,477 billion as of 31 August 2003 (please see Diagram 1-1 below). At present, almost all SEHK Trades are settled by CCASS on the basis of stocks already immobilised in CCASS.

Diagram 1-1
Shares Deposited into the CCASS Depository to Market Total
 (As of end August 2003)

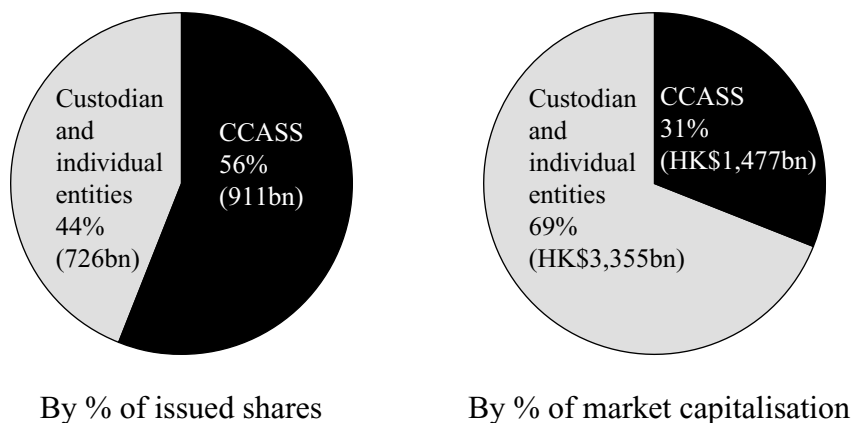

1.9 CCASS also acts as the central platform for the settlement of other market transactions of securities in Hong Kong by means of Settlement Instructions (“SI”) used by the CCASS Participants (other than Investor Participants). In 2002, CCASS processed on average of 16,000 SI per day, involving securities worth HK\$18.6 billion which was more than double the value of daily SEHK Trades (HK\$6.7 billion) and six times the value of daily Continuous Net Settlement (“CNS”) positions (HK\$3 billion). This central platform relies on two major success factors – first, broad participation (participation in CCASS of almost all active and major financial intermediaries, including about 450 brokers, 40 custodians and another local clearing company (SEOCH) as of August 2003) and secondly, a large depository. Through this central platform, CCASS helps improve settlement efficiency, and reduces risks and costs for the securities market.

CHAPTER TWO CURRENT CCASS OPERATION

HKSCC Participantship Structure

2.1 HKSCC currently has six categories of Participants, namely Broker Participant, Clearing Agency Participant, Custodian Participant, Stock Lender Participant, Stock Pledgee Participant and Investor Participant (“IP”). The number of Participants as of end August 2003 is as follows –

Broker Participants	445
Clearing Agency Participant	1
Custodian Participants	41
Stock Lender Participant	0
Stock Pledgee Participants	8
Investor Participants	13,161

2.2 Broker Participants must themselves also be SEHK participants. Broker Participants have the obligation to clear SEHK Trades with HKSCC.

2.3 At present, there is only one Clearing Agency Participant, namely the SEHK Options Clearing House Limited (“SEOCH”). SEOCH passes exercised stock option trades to HKSCC for settlement. Once passed to HKSCC, exercised option trades will be processed as if they were SEHK Trades. They will be novated and settled in CCASS on T+2.

2.4 Custodian Participants are mainly banks. They keep their clients’ shares in the CCASS Depository and settle trades and other transactions (such as stock borrowing and lending) on behalf of their clients with the Broker Participants and other CCASS Participants on the platform provided by CCASS. Unlike the Broker Participants, the Custodian Participants cannot settle SEHK Trades directly with HKSCC.

- 2.5 While the admission criteria for the Stock Lender Participants and the Stock Pledgee Participants differ from those applicable to the Custodian Participants, their scope of eligible transaction types in CCASS is in fact similar. As shown above, HKSCC currently has no Stock Lender Participant and only a few Stock Pledgee Participants. This is in part due to the fact that some Custodian Participants also perform the functions of these two categories of participants.
- 2.6 Investor Participants (“IPs”) are individuals and institutions who hold securities in CCASS of which they themselves are the beneficial owners. They have direct control over their shareholdings and may transfer securities to other CCASS Participants other than IPs. An IP however cannot transfer shares to another IP directly in CCASS due to stamp duty considerations.
- 2.7 HKSCC also offers the Stock Segregated Account with Statement Service to enable investors to reconcile their stockholdings and trading records kept by their brokers or custodians with statements issued by HKSCC. Investors who are interested in opening Stock Segregated Account with Statement should apply to HKSCC through CCASS Participants (other than IPs). CCASS Participants control and operate their Stock Segregated Accounts with Statement, but may authorise HKSCC to send statements of stock movements and balances of these Stock Segregated Accounts with Statement directly to their clients or any person designated by them. The designated recipient receives a movement statement when there has been any stock movement in the Stock Segregated Account with Statement and a monthly balance statement even when there is a zero balance or no movement during the month.

The CCASS Depository

- 2.8 As previously mentioned, CCASS operates on an immobilised basis. CCASS Participants deposit their securities in physical form into the CCASS Depository. The deposited shares will be then re-registered with the respective share registrars in the name of HKSCC Nominees and will be credited to the CCASS Participants’ accounts as electronic book entries. The CCASS Depository currently holds approximately six million share certificates representing approximately 30% of the total market capitalisation of the listed companies on SEHK.

Settlement in CCASS

- 2.9 HKSCC is the clearing house for SEHK Trades. It guarantees settlement for the Broker Participants and acts as the central counterparty for SEHK Trades by way of novation⁶. Settlement of SEHK Trades is fully automated. Details of trades matched on the Automated Order Matching and Execution System (“AMS”) are automatically transmitted to CCASS. These trades will then be novated and become positions for settlement. Positions are settled on a CNS basis two days after trade date (T+2). CNS positions from SEHK Trades will be settled electronically in CCASS by electronic debits and credits against the CCASS clearing accounts of the Broker Participants without the need to re-register legal title of the settled shares at the share registrars. Money settlement takes place electronically through the inter-bank clearing system. Isolated trades (“IT”) are settled on a trade-for-trade basis. HKSCC does not substitute itself as the settlement counterparty to IT to guarantee settlement.
- 2.10 HKSCC also processes other transactions among the CCASS Participants. They include Account Transfer Instructions (“ATI”), SI and Investor Settlement Instructions (“ISI”).
- 2.11 CCASS Participants (other than IPs) use ATI to move securities among their own various accounts.
- 2.12 Participants may transfer securities to other CCASS Participants (other than IPs) through the use of SI. Both the delivering Participant and the receiving Participant are required to input SI into CCASS. The SI will be matched before they are settled. Unmatched SI will not be settled. HKSCC provides various money settlement options for SI, namely Free of Payment (“FOP”), Delivery versus Payment (“DVP”) and Realtime Delivery versus Payment (“RDP”) options. Money settlement takes place at banks outside CCASS. HKSCC does not guarantee SI.

⁶ Novation means the process of substituting a new contract in place of an existing contract either between the same parties or between different parties. The existing contract will be discharged upon novation. In the case of CCASS, HKSCC becomes the contractual counterparty for both buying and selling brokers who were previously counterparties to each other in the trade.

2.13 ISI are used to transfer securities between an IP and other CCASS Participants. ISI are input by the CCASS Participant (usually a Broker Participant) and affirmed by the IP. ISI carry with them the same money settlement options as SI. ISI cannot be effected between two IPs. HKSCC also does not guarantee ISI.

Other HKSCC Services

2.14 Apart from clearing and settlement services, HKSCC also provides nominee services to its Participants in respect of shares deposited into the CCASS Depository. These services include –

- the collection and distribution of dividends, interests, redemption proceeds, distributions and rights;
- the appointment of Participants or persons they nominate as proxies or representatives of HKSCC or HKSCC Nominees for the purpose of attending and voting at shareholders' general meetings of the issuers;
- the seeking of instructions from Participants with regard to the exercise of rights or entitlements of their securities and other corporate actions; and
- the application for new shares.

CHAPTER THREE

PROPOSED OPERATIONAL MODEL FOR A SCRIPLESS SECURITIES MARKET

3.1 The proposals contained in the SFC Consultation Paper require the issuers whose shares are admitted into CCASS to have a CCASS Register and an Issuer Register. Diagram 3-1 is a high-level illustration of the proposed scripless securities market model.

Diagram 3-1
The Proposed Scripless Securities Market Model

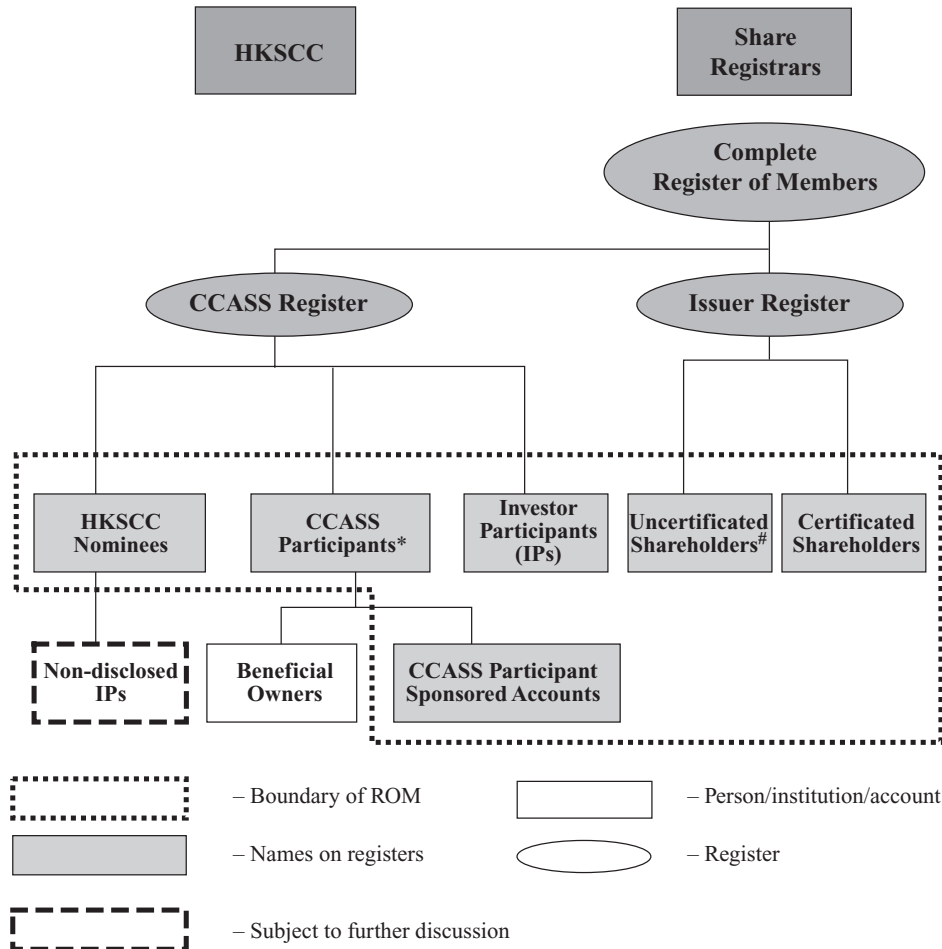

* The shareholdings of the CCASS Participants on the CCASS Register do not include those of the holders of the CCASS Participant Sponsored Accounts.

The SFC uses the term “Issuer Register Accounts” in its Consultation Conclusions.

3.2 In devising this scripless operational model, HKEx has attached substantial importance to the following principles and objectives –

- the model should maintain the current choices provided to investors, including the choice to register their shareholdings either directly in their own names or through market intermediaries and financial services providers such as brokers and custodians;
- the model should enhance market efficiency and thereby reduce costs;
- the model should facilitate fair allocation of costs through the user-pays principle;
- the model should improve protection to investors and reduce the risk of misappropriation; and
- the model should uphold current market integrity and system reliability levels.

3.3 Key features of the proposed scripless securities market model are as follows –

- Issuers whose shares are admitted into CCASS will have a CCASS Register and an Issuer Register. Both will be recognised under the law as registers of members. Shareholdings recorded on these registers are mutually exclusive. In other words, there will be no overlap of registered holdings;
- The Issuer Register will be maintained by the issuer or its appointed share registrar. It includes shares in uncertificated form outside of CCASS (i.e. not deposited in the CCASS Depository). So long as certificates remain an option to shareholders, the Issuer Register will also record shareholdings in certificated form;
- The CCASS Register will be maintained by HKSCC. It contains only uncertificated shares deposited into CCASS;

- HKSCC will copy the CCASS Register to the respective share registrars electronically by day end. The share registrar will then produce a complete register of members on the basis of the CCASS Register and the Issuer Register and make it available for public inspection;
- Settlement of SEHK Trades and registration at the Broker Participant level will happen simultaneously and automatically; and
- Uncertificated shares can be transferred electronically from the CCASS Register to the Issuer Registers and vice versa.

3.4 According to the SFC Consultation Paper, the new legislation would apply to “securities” to be defined broadly as the term is defined in the Securities and Futures Ordinance. This would enable the scripless regulations to cover not only shares and debentures, but other listed products such as warrants and exchange-traded funds. Should such other forms of securities be included in the scope of scripless legislation, the proposals made in this Consultation Paper would also be applicable to them.

The Issuer Register

3.5 As Diagram 3-1 shows, the Issuer Register maintained by a share registrar will contain two different types of shareholdings – certificated and uncertificated. Certificated shareholdings will work essentially in the same way as with the current physical scrip system. Uncertificated shares can be transferred electronically from the Issuer Register to the CCASS Register and vice versa. At such time as the Hong Kong market is completely dematerialised, the Issuer Register will contain only uncertificated shareholdings.

3.6 For each uncertificated shareholding registered by an investor on the Issuer Register, the share registrar will assign a unique Shareholder Reference Number (“SRN”) to the investor. The SRN is issue-specific. It will be issued and managed by the share registrars. Hence, if an

investor owns shares of a number of companies that are registered on the Issuer Register, the investor will have several SRNs. The SRN will be used to identify uncertificated shareholdings for transfer from the Issuer Register to the CCASS Register (for transfer from the CCASS Register to the Issuer Register, name and address with or without SRN will be used). More details on these inter-register transfers and the SRN will be provided below.

The CCASS Register

- 3.7 The CCASS Register will be identical to the shareholding record of the CCASS Depository for those shares that have been dematerialised. Whereas under the current immobilisation system, all shares deposited by the CCASS Participants are registered in the name of HKSCC Nominees, under the scripless securities market model, shareholdings in CCASS will be registered directly in the names of the CCASS Participants or the holders of the CCASS Participant Sponsored Accounts. HKSCC will be subject to legislation defining in the CCASS Rules and Operational Procedures which types of securities and accounts in CCASS will be “name-on-register”. At the moment, there are securities which are traded on SEHK but issued in overseas jurisdictions. Where these overseas jurisdictions do not allow the issue of uncertificated shares, so long as they are deposited into the CCASS Depository, they will continue to be registered in the name of HKSCC Nominees.

The Complete Register of Members

- 3.8 The share registrar will produce a complete register of members on the basis of the CCASS Register and the Issuer Register. To achieve this, HKSCC will pass a copy of the CCASS Register at the end of each business day to the respective share registrars. The share registrars will reconcile the two registers to make sure that inter-register transfers and other processes affecting shareholding such as bonus shares, share consolidation or stock splits are properly recorded. The share registrars will also verify that the total number of shares on the two registers equals the total number of issued shares. Later in this Chapter, we will discuss in detail how the day-end register-related processing and reconciliation will take place.

- 3.9 We have considered whether HKSCC should pass all CCASS transaction data, including the settlement of CNS trades, IT, SI, ISI and ATI, to the share registrars. We do not think it is cost effective to do so as the volume of data involved would be huge. For the share registrars to track the movements during the day on the CCASS Register, they will in effect have to perform the CCASS transactions all over again on their systems. Technically speaking, we are not sure whether it is feasible or desirable for the share registrars to reproduce or re-construct share movements in CCASS even if all data and information were to be passed to them. In addition, we are unsure if the market would consider it appropriate for HKSCC to provide information of the CCASS transactions to third parties for non-regulatory related matters.
- 3.10 The share registrars will make available the complete registers of members for public inspection, as they currently do. The CCASS Register will not be open directly to public inspection at the premises of HKSCC.
- 3.11 Appendix 2 illustrates how reconciliation in respect of the inter-register transfers during the day will be made.

HKSCC Participantship and Direct Registration

- 3.12 The existing categories of CCASS Participants will be maintained under the scripless securities market model. They are–
- Broker Participant;
 - Clearing Agency Participant;
 - Custodian Participant;
 - Stock Lender Participant;
 - Stock Pledgee Participant; and
 - Investor Participant.

In addition, a new account type – CCASS Participant Sponsored Account, and a new category of participant – Registrar Participant will be added in CCASS upon the implementation of the scripless securities market model.

- 3.13 CCASS Participant Sponsored Accounts will have to be sponsored by CCASS Participants (other than IPs). The CCASS Participants will operate these accounts, including stock transfers to other accounts within CCASS, stock withdrawal out of CCASS and corporate action instructions, on behalf of the account holders. HKSCC will not accept any liability to the holders of the CCASS Participant Sponsored Accounts for any loss which they may incur as a result of the acts and omissions of their sponsoring CCASS Participants. If the sponsoring CCASS Participant gives HKSCC an instruction, it will generally be executed by HKSCC regardless of any instruction the holder of the CCASS Participant Sponsored Account may give HKSCC to vary or reject it.
- 3.14 While the holders of the CCASS Participant Sponsored Accounts will not have direct access to CCASS, they will receive from HKSCC statements of their account balance and activities on both periodic and on ad hoc bases (the latter when there are stock movements in their accounts). The CCASS Participant Sponsored Account concept stems from the existing Stock Segregated Account with Statement Service in CCASS where the account holder receives account statements directly from HKSCC but he or she can only operate the account through his or her Broker or Custodian Participant. However, the holders of the CCASS Participant Sponsored Accounts will appear on the CCASS Register as registered shareholders whereas holders of the current Stock Segregated Accounts with Statement are not recognised as registered holders of the securities in such accounts. CCASS Participant Sponsored Accounts are optional to both CCASS Participants and investors.
- 3.15 As registered shareholders, the holders of the CCASS Participant Sponsored Accounts would have a higher level of protection as compared with the non-disclosed clients of the sponsoring CCASS Participant because in the event of liquidation of the sponsoring CCASS Participant, the liquidator or the administrator should be readily able to

distinguish their assets from those of the sponsoring CCASS Participant. Moreover, they are entitled to receive corporate communications directly from the issuers.

3.16 HKSCC does not have a direct relationship with the share registrars at the moment. For the implementation of a scripless securities market, we need a mechanism to facilitate future technical development relating to the scripless market infrastructure with the share registrars and establish electronic linkages with them. The technical and operational requirements, and responsibilities of HKEx and the share registrars in respect of the operation of the scripless securities market have to be agreed between the two parties and clearly set out in writing. Moreover, to increase the transparency, the service level for the inter-register transfers should also be made available to the public. We believe these objectives could be achieved through CCASS participantship.

3.17 After scripless, share registrars will continue to be regulated by the SFC under the Code of Conduct of Share Registrars. All Approved Share Registrars under the Securities and Futures Ordinance will be eligible for admission to CCASS. Similar to the admission of other CCASS Participants and Designated Banks, HKSCC will set out the admission procedures for Registrar Participants and process their applications accordingly.

3.18 The admission of share registrars into HKSCC will enable them to perform transactions in CCASS and enable HKSCC and the share registrars to define and enforce through the CCASS Rules and Operational Procedures the technical and operational requirements under the scripless securities market model. Registrar Participants will not be included on the CCASS Register. In fact, Registrar Participants should not have shares deposited into CCASS. Their participantship is essentially to facilitate the operation of the scripless securities market. Hence, Registrar Participants will not have the obligation to clear SEHK Trades as the Broker Participants. Due to the business nature of the share registrars, existing transaction types in CCASS (such as SI, ISI and ATI) will in large part not be applicable to Registrar Participants. New transaction types will be developed specifically for them. To minimise the scripless development costs to the market and the share

registrars, we propose that share registrars will use CCASS Terminals or Participant Gateways (“PG”) to communicate with CCASS.

3.19 If CCASS participants for share registrars is for some reason considered neither desirable nor appropriate, we are happy to consider suggestions from the market, in particular the Federation of Share Registrars, on other feasible ways to achieve the above objectives.

3.20 HKEx is currently reviewing the IP Account services provided by HKSCC. One of the features under consideration which relates to scripless is whether there should be an option for IPs to choose to continue to register their shares in the name of HKSCC Nominees (non-disclosed IP Accounts). It is our view that investors should continue to be given that option by HKEx. Subject to the review on IP Account services and the market feedback, the scripless securities market model may need to be further modified in relation to IPs.

3.21 Assuming that the option would be provided, the shares of the non-disclosed IPs will be registered in the name of HKSCC Nominees. The operations of disclosed IP Accounts and non-disclosed IP Accounts will be very similar. All IPs can move shares to the CCASS Participants (other than IPs) by using ISI. HKSCC will send statements to the IPs and they can make any enquiries in respect of their accounts and give instructions to HKSCC by the Interactive Voice Response System (“IVRS”), the Internet or via the service counter. All IPs will also receive corporate communications directly from the share registrars. However, for corporate actions, HKSCC Nominees will have to consolidate the instructions of the non-disclosed IPs. Therefore, the deadline for corporate actions for the non-disclosed IPs may be earlier than that for the disclosed IPs.

3.22 HKSCC Nominees will continue to exist but its functions will be limited to the operational needs of CCASS and to holding shares of non-disclosed IPs. It will receive instructions from the non-disclosed IPs and exercise rights on behalf of the shareholders. It will also receive entitlements from the issuers/share registrars and distribute them to the non-disclosed IPs.

3.23 After the implementation of a scripless securities market, the shares of the following accounts will be registered directly in the names of the holders of the respective accounts on the CCASS Register –

- Broker Participant Accounts;
- Custodian Participant Accounts;
- Clearing Agency Participant Accounts;
- Stock Lender Participant Accounts;
- Stock Pledgee Participant Accounts;
- Disclosed IP Accounts; and
- CCASS Participant Sponsored Accounts.

The CCASS Depository and Physical Deposits

3.24 Scrip in the CCASS Depository will be dematerialised gradually upon the implementation of a scripless securities market. Upon complete dematerialisation of the CCASS Depository, the CCASS Depository will no longer hold physical certificates, except for transient purposes in respect of the shares subsequently deposited into the CCASS Depository with it.

3.25 The CCASS Depository will continue to accept deposits of physical certificates. Deposited scrip will be delivered by HKSCC to the share registrars for dematerialisation, and will be credited to the CCASS Participants' accounts upon confirmation from the share registrars to HKSCC. At the point of crediting, the shares will also be registered on the CCASS Register in the names of the depositing Participants. Simultaneously, those shares will be removed from the certificated shareholding record on the Issuer Register. Diagram 3-2 below illustrates the process.

Diagram 3-2
Post-scriptless Physical Deposits into the CCASS Depository

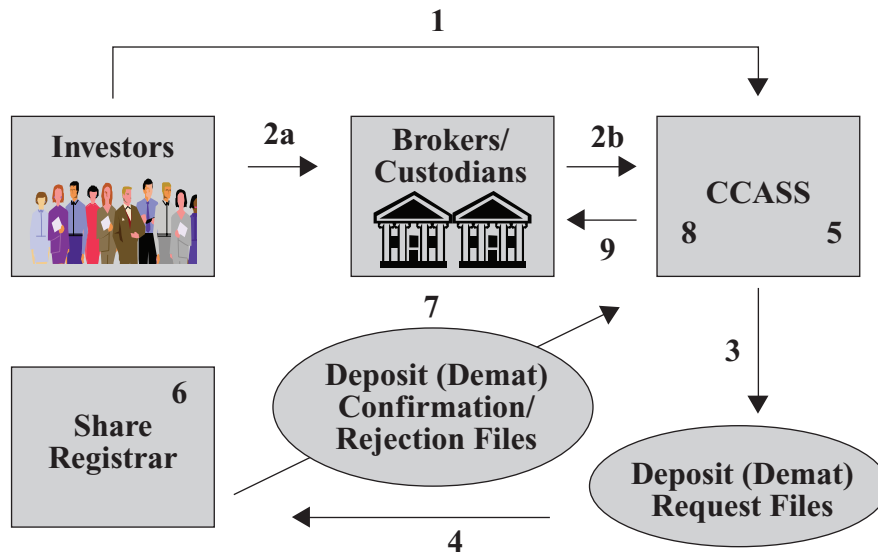

The key process flow is as follows –

Instruction Day (“ID”)

1. Investor who is an IP delivers certificates to the CCASS Depository.
- 2a. Alternatively, investor who is not an IP delivers certificates to a CCASS Participant (other than an IP) for onward deposit into the CCASS Depository.
- 2b. The CCASS Participant delivers clients’ certificates to the CCASS Depository.
3. HKSCC inputs Deposit Instructions and generates Deposit (Dematerialisation) Request Files by stock at day end.
4. The share registrar downloads Deposit (Dematerialisation) Request Files from CCASS.
5. HKSCC delivers certificates deposited into the CCASS Depository to the share registrar.

ID to Day X

6. The share registrar verifies certificates and reconciles with the CCASS' Deposit (Dematerialisation) Request Files.

Day X

7. The share registrar generates Deposit (Dematerialisation) Confirmation/Rejection Files for upload to CCASS at day end and debits the relevant certificated shareholding records on the Issuer Register.
8. HKSCC credits the receiving accounts at day end and updates the CCASS Register. HKSCC also informs the CCASS Participant of the rejected deposits by way of Rejected Deposits Files. Deposited shares are available for CCASS settlement at the beginning of the following business day.
9. HKSCC informs the CCASS Participant of the result of the transaction.

3.26 It is proposed that immediate credit of deposited shares will no longer be provided to CCASS Participants upon implementation of the scripless securities market model. The reasons are: (1) physical certificates deposited into CCASS will only be credited into the CCASS accounts after the relevant shares are debited from the Issuer Register. Otherwise, the total number of shares on the two registers will exceed the number of issued shares; and (2) this is to avoid the risk of defective certificates to HKSCC. In this circumstance, deposited shares will be available for settlement on the following business day after CCASS receives confirmation from the share registrars. At present, the share registrars issue certificates within ten business days of the receipt of properly executed transfer documents or within three or six business days for the shareholders who are willing to pay higher fees. The time taken to complete the dematerialisation process depends on the service provided by the share registrars. The Federation of Share Registrars is considering if they can do it in the future in shorter time, so that investors who deliver physical certificates to their brokers at the time of order placing will have their shares available for settlement in time.

3.27 Since the scrip in the CCASS Depository will be dematerialised, CCASS Participants will no longer be able to withdraw physical scrip directly from CCASS once it has been dematerialised after implementation of the scripless securities market model. If CCASS Participants want to convert their electronic shareholdings in CCASS into certificates (rematerialisation), they may input the request into CCASS and HKSCC will pass the request to the relevant share registrar. CCASS Participants will collect the scrip from the share registrars. The rematerialisation process will be discussed in more detail later in this Chapter.

Clearing and Settlement Services

3.28 As the SFC Consultation Paper has pointed out, the clearing and settlement functions of CCASS will not be affected by the implementation of scripless. The key features of settlement of SEHK Trades, including novation, CNS and T+2 settlement cycle, will remain unchanged. The only exception is that when the law recognises the CCASS Register as a register of members, settlement of securities will also have the effect of a change of legal title. These two functions (i.e. settlement and registration) will happen simultaneously in CCASS.

3.29 CCASS currently has an on-hold mechanism to protect HKSCC from Broker Participant default. Under the on-hold mechanism, shares delivered to a long Broker Participant are locked and are not available for other uses to the Broker Participant unless and until its money obligation is settled. If the Broker Participant fails in its payment obligations to HKSCC, the shares subject to the on-hold restriction will be liquidated, and the proceeds used to make good the default payment to HKSCC. To maintain adequate protection to HKSCC under the scripless securities market model, HKSCC will define in its Rules that a change of legal title is final and further explore the concept of holding a lien over the securities in the CCASS clearing account of the Participant concerned including the delivered shares subject to the “on-hold” restriction. Presently we are seeking legal advice as to whether the “on-hold” arrangement needs to be supported by law.

Broker-Client Settlement and Client Level Registration

- 3.30 Settlement at the broker-client level remains a matter between the broker and its clients. While settlement of SEHK Trades and registration at the Broker Participant level will occur simultaneously and automatically after the implementation of a scripless securities market, registration of the purchased shares at the beneficial owner (i.e. investor) level will remain entirely optional to the investor. If an investor chooses to keep his or her shares with his or her broker, no further transfer (and registration) would be required. Should the investor so desire, the broker may transfer the shares of the investor (after settlement with HKSCC) from its CCASS account to the investor's shareholding account either on the CCASS Register (CCASS Participant Sponsored Account or Investor Participant Account) or on the Issuer Register.
- 3.31 Under the scripless securities market model, a new type of CCASS transaction will be introduced, namely Sponsored Account Transfer Instructions ("SATI"). SATI will be used to transfer shares from the accounts of the sponsoring CCASS Participants to the CCASS Participant Sponsored Accounts, and vice versa. SATI will work exactly in the same way as ATI. They will be input by the sponsoring CCASS Participants and will not require matching or affirmation. Different from ATI, shares transferred by SATI will involve a change of legal title on the CCASS Register. SATI cannot be used to transfer shares to other CCASS Participants.

Other CCASS Transactions

- 3.32 Shares deposited into the CCASS Depository may be transferred from one account to another through SI and ISI. The manner in which they are processed within CCASS will remain unchanged, again with the exception that a change of legal title will, after implementation of scripless, happen simultaneously with securities settlement. As is currently the case, ISI cannot be used to transfer shares between two IPs for stamp duty reasons.

3.33 A CCASS Participant (other than an IP) may use ATI to transfer securities among its own various stock accounts. There will be no change of legal title for ATI since the shares will continue to be registered on the CCASS Register in the name of that CCASS Participant.

Inter-register Transfers: EDI and EWI

3.34 Upon implementation of a scripless securities market, uncertificated shares can be transferred electronically between the Issuer Register and the CCASS Register. Transfer of shares from the Issuer Register to the CCASS Register is in effect a deposit into the CCASS Depository whereas the reverse is a withdrawal.

3.35 Such transfers will be supported in the CCASS infrastructure. Two new instruction types will be introduced by HKSCC, namely Electronic Deposit Instruction (“EDI”) and Electronic Withdrawal Instruction (“EWI”). They have been developed on the assumption that the proposal by the Federation of Share Registrars to use the SRNs will be acceptable and adopted by the market. As we will discuss in more detail in Chapter Eight, the security issues relating to the use of SRN need to be discussed and understood more thoroughly by both the market intermediaries as well as the investing public.

3.36 To transfer shares from the Issuer Register into the CCASS Register (i.e. electronic deposit), a CCASS Participant will have to input an EDI to CCASS. An EDI will include the following information –

- The name of the delivering registered shareholder on the Issuer Register;
- His or her address as recorded on the Issuer Register;
- The relevant SRN;
- The receiving account number in CCASS;
- The stock code; and

- The quantity of shares to be transferred.

Diagram 3-3 below illustrates how an EDI will be processed.

Diagram 3-3
Process Flow of an Electronic Deposit Instruction

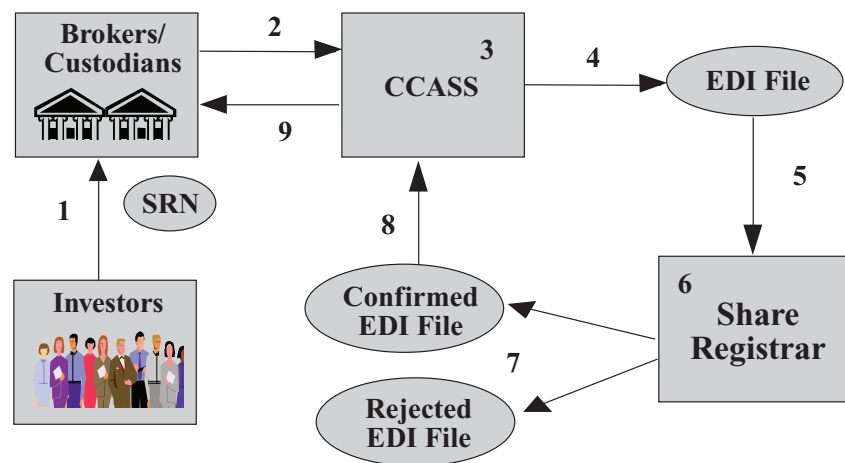

The key process flow of an EDI is as follows –

1. Investor discloses the SRN to a CCASS Participant (other than an IP);
2. Initiating CCASS Participant inputs an EDI to CCASS;
3. HKSCC checks if the EDI contains all the required information. If not, the EDI will be rejected. (Note: HKSCC will not be able to verify if the SRN and the shareholder details are valid as it does not have such information);
4. HKSCC creates EDI Files by stock encompassing all validated EDIs of the same stock at day end;
5. The share registrar downloads the EDI Files from CCASS at day end;

6. The share registrar verifies the EDIs and checks if the delivering shareholder has adequate stocks on the Issuer Register. If so, the relevant shareholding record will be debited. If not, or if the information contained in the EDI does not match the record on the Issuer Register (such as a wrong SRN, wrong shareholder name or wrong address), the EDIs will be rejected;
7. The share registrar creates a Confirmed EDI File and a Rejected EDI File;
8. The share registrar uploads both files to CCASS; and
9. HKSCC credits the receiving CCASS Participant accounts in accordance with the confirmed EDIs. HKSCC also sends Rejected EDI messages to the initiating CCASS Participant in accordance with the rejected EDIs.

3.37 Shares deposited by means of EDI will be registered on the CCASS Register at the end of the input day and will be available for settlement on the following business day of HKSCC. Investors who are selling their uncertificated shares on the Issuer Register should therefore deposit their shares into CCASS by EDIs not later than T+1 for T+2 settlement.

3.38 CCASS Participants may electronically withdraw shares from the CCASS Register and be registered as uncertificated shareholders on the Issuer Register using an EWI. An EWI will include the following information –

- The delivering account number in CCASS;
- The name of the recipient in which the shares will be registered on the Issuer Register;
- His or her address to be registered on the Issuer Register;
- The relevant SRN (where applicable);

- The stock code; and
- The quantity of shares to be transferred.

Diagram 3-4 below illustrates how an EWI will be processed.

Diagram 3-4
Process Flow of an Electronic Withdrawal Instruction

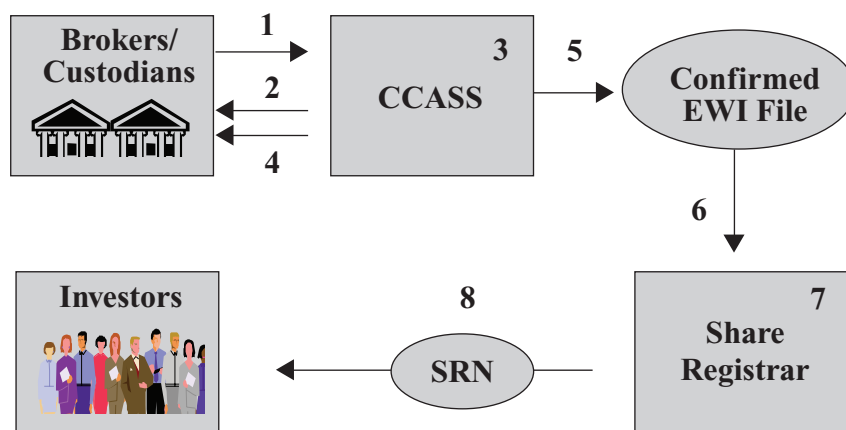

The key process flow of an EWI is as follows –

1. CCASS Participant inputs an EWI to CCASS;
2. HKSCC checks if the EWI contains all the required information. If not, the EWI will be rejected.
3. HKSCC processes the validated EWIs at day end and debits shares from the delivering account;
4. If the delivering account does not have sufficient shares to satisfy the debit, HKSCC issues a Failed EWI message to the initiating CCASS Participant;
5. HKSCC creates Confirmed EWI Files by stock after the EWI processing at day end;

6. The share registrar downloads the Confirmed EWI Files from CCASS;
7. The share registrar credits the shares to the receiving shareholders. If the registration details in the EWI does not match with the record of the SRN received or no SRN is provided, the share registrar will create a new shareholding record on the Issuer Register and generate a new SRN for the shareholding;
8. The share registrar mails a statement with an SRN to the shareholder at the address contained in the EWI.

3.39 The share registrars will not reject EWIs confirmed by CCASS. Shares withdrawn from the CCASS Depository by means of EWI will be registered on the Issuer Register at the end of the input day.

3.40 The features of EDIs and EWIs resemble current deposits and withdrawal activities, including –

- There will be no money settlement options accompanying EDIs and EWIs;
- HKSCC will not guarantee EDIs and EWIs for their counterparties. They will be executed only if shares are available in the delivering accounts on the Issuer Register or the CCASS Register; and
- EDIs and EWIs will be processed on a gross, transaction-by-transaction basis.

3.41 We propose that EDIs and EWIs be processed on a batch mode at day end. At present, HKSCC handles on average approximately a total of 1,000 deposit and withdrawal requests per day and this number may increase to more than 3,000 on a heavy trading day. Real-time processing of these transactions will inevitably consume more capacity and resources of CCASS and will create additional traffic and load on the CCASS Network. In addition, the CCASS processing schedule will have to be changed and CCASS and the share registrars' systems will need more enhancements to support real-time processing. Hence, the

cost for implementing real-time processing will be higher. Moreover, the implementation of a scripless securities market is a major change for the financial market. It is therefore more appropriate to adopt a prudent and progressive implementation approach. Should inter-register transfers become real-time at the initial launch of scripless, in the unlikely event such as data corruption incident happening in either the CCASS or share registrars' systems, settlement and registration activities will be affected and the trading market operations may also be hindered. A batch mode will result in less system inter-dependency between the CCASS Register and the Issuer Registers. Batch mode would therefore seem more prudent and cost-effective. HKSCC will monitor the activities of EDI and EWI after the implementation of scripless and review together with the SFC and the Federation of Share Registrars, on a need basis, if its processing mode should be changed.

3.42 Technically, HKEx could support more frequent processing of EDIs and EWIs, such as multiple batches or even real-time, if the market confirms that there is such a need. More frequent processing would inevitably increase costs to HKSCC and possibly also the share registrars, which ultimately would be borne by the market users themselves. Costs apart, the corresponding operational, technical, integrity and reliability requirements on the systems of the share registrars would also increase. If there is adequate assurance that the integrity, efficiency and reliability of CCASS would not as a result of these processes be compromised and the risks to the market could be properly managed, HKEx is prepared to support more frequent processing of EDIs and EWIs.

3.43 EDI and EWI will not include stamp duty payment. When CCASS Participants (other than IPs) initiate EDIs or EWIs, they remain liable for stamp duty if the transactions are in fact dutiable transfers of shares. The holders of the CCASS Participant Sponsored Accounts may request their sponsoring CCASS Participants to input EDIs or EWIs to CCASS, the Participants will again be liable for the stamp duty requirement, if applicable. For EDIs or EWIs initiated by IPs, the registered shareholders on the Issuer Register must be the same person to prevent avoidance of stamp duty and abuse.

3.44 EDI and EWI will be subject to a fee by HKSCC payable by the CCASS Participants who initiate the transactions. It is expected that the fee will be transaction-based.

Dematerialisation

3.45 There are two means for shareholders to dematerialise their scrip –

- a. through CCASS; or
- b. at the share registrars.

Dematerialisation through CCASS is physical deposits into the CCASS Depository, which was discussed earlier in this Chapter (please refer to the section on “The CCASS Depository and Physical Deposits”).

3.46 Alternatively, shareholders may have their scrip dematerialised directly by the share registrars. Once dematerialised, the shares will be debited from the certificated shareholding record and credited to the uncertificated shareholding record on the Issuer Register. Investors will receive SRNs from the share registrars by mail. Diagram 3-5 illustrates how the dematerialisation process at the share registrars will take place.

Diagram 3-5
Dematerialisation at the Share Registrars

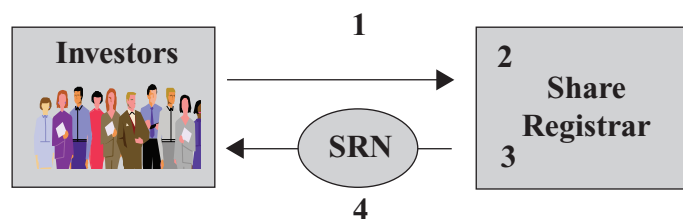

Instruction Day (“ID”)

1. Investor delivers scrip to the share registrar for dematerialisation;

ID to Day X

2. The share registrar verifies the request and the scrip;

Day X

3. The share registrar debits the certificated shareholding record and creates the corresponding uncertificated shareholding record on the Issuer Register at day end; and
4. The share registrar sends a statement with an SRN to the investor.

Rematerialisation

3.47 The SFC Consultation Paper suggests that uncertificated shares may be “rematerialised” at the request of shareholders if they so wish. To rematerialise their uncertificated shares, the CCASS Participants may submit their requests to HKSCC. A rematerialisation request will include the following information –

- The delivering account number in CCASS;
- The stock code;
- The quantity of shares to be rematerialised; and
- The name and address in which the rematerialised shares will be registered.

Diagram 3-6 illustrates the process flow of a rematerialisation request.

Diagram 3-6
Processing of a CCASS Rematerialisation Request

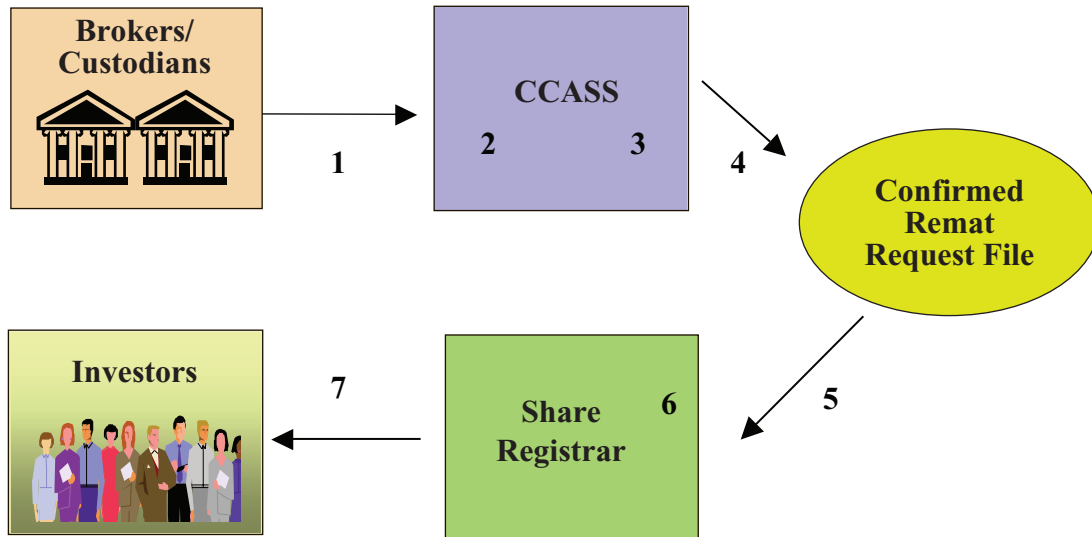

Instruction Day (“ID”)

1. CCASS Participant inputs a rematerialisation request to CCASS;
2. HKSCC checks if the rematerialisation request contains all the required information. If not, the request will be rejected;
3. At day end, HKSCC checks if there are the required shares in the CCASS Participant’s account for rematerialisation. If so, HKSCC debits the shares from the account on the CCASS Register, if not, HKSCC rejects the request;
4. HKSCC creates Confirmed Rematerialisation Request Files by stock;
5. The share registrar downloads the Confirmed Rematerialisation Request Files from CCASS;
6. The share registrar credits shares to certificated shareholding records on the Issuer Register;

Day X

7. Certificates ready for collection from the share registrar.

3.48 Uncertificated shareholders on the Issuer Register may rematerialise their uncertificated shares directly at the share registrars. The detailed procedures may vary from one share registrar to another.

Overview of Post-scripless CCASS Transaction Types

3.49 For easy reference, Appendices 3A-3C provide respectively an overview of the post-scripless transaction types of CCASS, the share registrars and between CCASS and the share registrars as discussed in this section.

Post-scripless CCASS Infrastructure and Processing Schedule

3.50 To implement the scripless securities market model, it is necessary for the share registrars to be connected to CCASS. HKSCC will modify the CCASS front end (CCASS Terminal and PG) and CCASS itself to support the additional transaction types and processes. Diagram 3-7 below provides an overview of the post-scripless CCASS infrastructure.

Diagram 3-7
Post-scripless CCASS Infrastructure

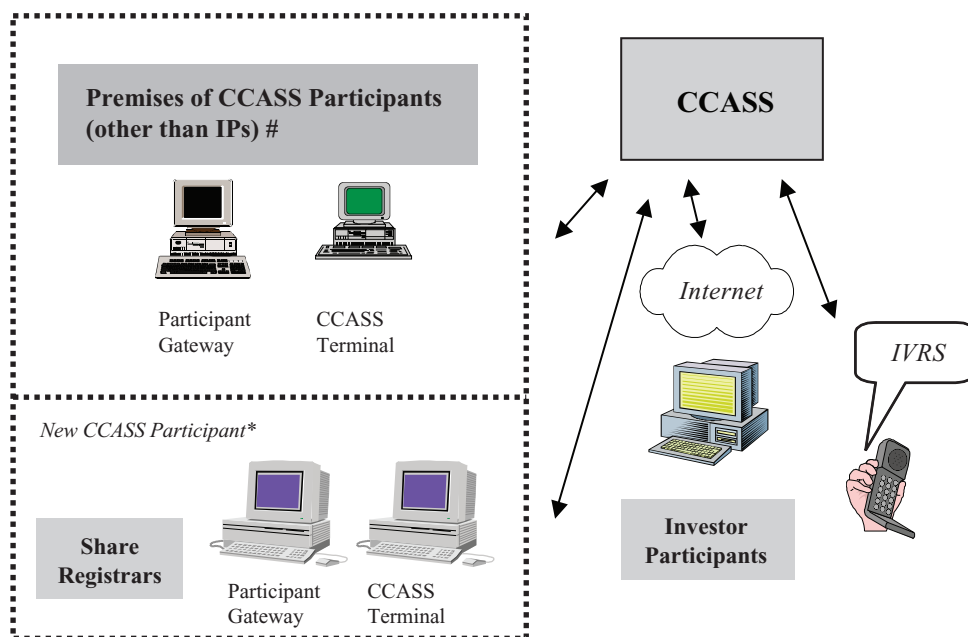

The holders of the CCASS Participant Sponsored Accounts will not have direct access to CCASS.

* As proposed in this Consultation Paper.

CCASS Processing Schedule

3.51 Existing CCASS job activities during market trading hours will remain unchanged. The following additional batch processes will be added to the day-end processing of CCASS –

- EWIs;
- Rematerialisation requests;
- EDIs;
- Physical deposit (or dematerialisation) requests;
- Corporate actions (such as bonus shares, share consolidation and stock splits etc.);
- Register reconciliation with the share registrars; and
- Generation of the CCASS Register day-end image.

These processes will be closely synchronised with the mirror processes to be performed at the share registrars. Specific time windows for different processes will be defined in the CCASS Operational Procedures as appropriate. HKSCC will forward the results of the above processes at day end to the CCASS Participants, who will then inform their clients of the results of their requests. Adequate contingency procedures will be laid down in case of process failures on the part of CCASS or the share registrars. A high-level CCASS processing schedule after the implementation of the scripless securities market model is contained in Appendix 4. Appendix 5 shows the interactions between CCASS and the systems of share registrars during the day-end processes.

CHAPTER FOUR

CCASS DEMATERIALISATION PROGRAMME

Progressive Approach

- 4.1 The SFC Consultation Paper proposes that Hong Kong should not move to a complete scripless securities market environment until it is widely accepted by the market and the investors. It will be up to the Government to judge as to when the market is ready for full implementation of a scripless securities market.
- 4.2 Upon implementation of a scripless securities market, HKSCC will progressively dematerialise all shares deposited into the CCASS Depository, with a view that ultimately the CCASS Depository will become completely scripless. This will take place in successive phases.
- 4.3 Our current thinking is that a pilot run will be launched in which a limited number of stocks with low turnovers will be identified for initial dematerialisation. The pilot run will be conducted over a weekend to minimise inconvenience or possible disruption to the market. The details of the scrip held in the CCASS Depository will be reconciled against the records of the share registrars before registration. After validation, the certificates will be disposed of. CCASS will produce the registers for the dematerialised stocks which will reflect the shareholdings of the CCASS Participants. The dematerialised stocks will no longer be available for physical withdrawal from HKSCC.
- 4.4 If the pilot run works smoothly, the dematerialisation programme will continue with the remaining stocks in batches on roughly a bi-weekly basis. The dematerialisation process is expected to take approximately six to twelve months. (Please see Diagram 4-1 below.) The major advantage of the progressive approach is that it can gradually prepare

the market and its users for a scripless environment. HKSCC will, in consultation with the share registrars, the SFC and the issuers, work out a detailed dematerialisation implementation programme.

Diagram 4-1
Dematerialisation – Progressive Approach

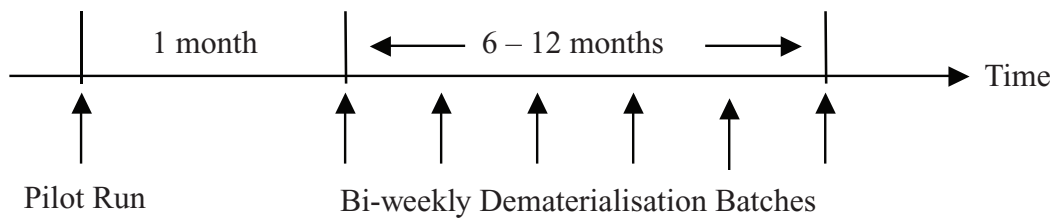

CHAPTER FIVE

SERVICES TO SHAREHOLDERS

Corporate Communications

- 5.1 It is proposed that share registrars will continue to provide corporate communications to all registered shareholders on the registers of members, containing both the Issuer Register and the CCASS Register. Non-disclosed investors under the CCASS Register may request through their brokers and custodians to receive corporate communications directly from the issuers. HKSCC will, as at present, consolidate such requests and pass the detailed information (including the names and addresses) to the relevant share registrars.

Corporate Action Services

- 5.2 At present, HKSCC, through HKSCC Nominees, provides corporate action services to its Participants. As HKSCC Nominees is the registered owner of the shares in CCASS, it will receive share entitlements such as dividends and can exercise shareholders' rights such as voting, rights issues, cash offers and warrant conversions. When HKSCC receives share entitlements such as dividends and bonus issues, it credits them to Participants' accounts in proportion to their shareholdings in CCASS. In the case of shareholder rights such as voting, HKSCC consolidates voting instructions from the Participants and votes accordingly on their behalf.
- 5.3 The current corporate action services provided by HKSCC are largely automated and are provided electronically through the CCASS infrastructure. CCASS Participants are able to receive up-to-date information on corporate actions on a timely basis via various communication channels such as CCASS Terminal, PG, IVRS and Internet. On the other hand, CCASS Participants can give CCASS their instructions through the same channels. CCASS Participants (other than IPs) through their own means disseminate the relevant corporate action information to their customers and collate instructions from them for submission to and consolidation by CCASS. These services are currently used by a large retail investor population in Hong Kong. We believe that these important functions of HKSCC are useful value-

added services to the market. We therefore propose that HKSCC will continue to serve its Participants and their clients on corporate actions. The shareholders on the Issuer Register will continue to be served by the share registrars directly.

5.4 Post-scripless, HKSCC will no longer be the nominee in respect of the shareholdings in the CCASS Depository. In order to continue to provide corporate action services to its Participants, necessary arrangements need to be put in place. In any case, HKSCC will continue to interact primarily with the share registrars for the provision of corporate action services to its Participants as is the case today. One immediate benefit to CCASS Participants under this proposal is that they will be able to have the same corporate action deadlines set by the issuers for the registered shareholders on the Issuer Register. HKSCC will be able to pass on the instructions of the CCASS Participants without the need of consolidating them to the relevant share registrar as and when received leading up to the deadline.

5.5 In the following paragraphs, we set out some details of the proposed corporate action services to the CCASS Participants in which CCASS will act as a conduit to collect corporate action entitlements and distribute the same to the relevant CCASS Participants. This approach is similar to the existing model used by CREST in the U.K. for serving its members.

Benefit Entitlement (Without Option)

5.6 It is proposed that HKSCC will generate receivables to its Participants on the CCASS Register for their entitlements on shareholdings of the relevant stock maintained with CCASS as of the record date. HKSCC will arrange cash entitlements such as dividends to be credited to the relevant Participants' Designated Bank accounts on the payment date. The share entitlements such as scrip dividend, bonus issue and warrant issues etc. will be credited to the Participants' stock accounts in CCASS at day end of the payment date.

Benefit Entitlement (With Option)

- 5.7 HKSCC will take a snapshot on the record date and generate electronic election instructions to all relevant Participants on the CCASS Register. CCASS Participants can input their election instructions on or before the deadline. The holders of the CCASS Participant Sponsored Accounts may submit their election instructions via their respective sponsoring CCASS Participants. HKSCC will pass on the election details of each instruction input by the Participants to the share registrars at day end during the election period electronically. It is proposed that HKSCC will follow the same deadlines as the relevant share registrar. On payment date, scrip dividends or cash entitlements will be credited to the respective Participants' stock accounts or Designated Bank accounts accordingly.

Subscription

- 5.8 At present, HKSCC Nominees collects and consolidates subscription instructions from its Participants electronically through CCASS. Corporate action activities include rights subscription, exercise of warrants and acceptance of the takeover offers etc. Post-scripless, CCASS Participants will continue to receive the relevant information via HKSCC. They can provide their subscription instructions through the same channels. The holders of the CCASS Participant Sponsored Accounts may submit their subscription instructions via their sponsoring CCASS Participants. HKSCC will arrange to debit the shareholdings from their stock accounts for subscription and the relevant subscription monies from their Designated Bank accounts on the instruction authorisation date. The scrip entitlement will be credited to the relevant CCASS Participants' accounts and the cash entitlement will be credited to the Designated Bank accounts on the payment date.
- 5.9 For corporate activities with a subscription deadline, the current deadline for the CCASS Participants to input the subscription instructions is normally one day before the share registrar's deadline. Post-scripless, the subscription deadline will be the same as the issuer's prescribed deadline.

Voting

5.10 CCASS Participants on the CCASS Register can submit their voting instructions to appoint the chairman of the meeting to vote on their behalf at general meetings. The holders of the CCASS Participant Sponsored Accounts may submit their voting instructions via their sponsoring CCASS Participants. HKSCC will forward each of these instructions to the issuer via the share registrar. It is proposed that the voting deadline be the same as the deadline prescribed by the issuer. CCASS Participants and the holders of the CCASS Participant Sponsored Accounts will be the shareholders of the company, and will have the right to attend the meetings in person or appoint corporate representatives to attend and vote at the meetings as the case may be.

CHAPTER SIX

INITIAL PUBLIC OFFERINGS

6.1 At present, the investors may subscribe to an IPO via the following channels –

- White application form (allotted shares issued in the name of the applicant);
- Yellow application form (allotted shares issued in the name of HKSCC Nominees);
- CCASS EIPO (optional to issuers and allotted shares issued in the name of HKSCC Nominees); and
- eIPO (optional to issuers and allotted shares issued in the name of the applicants).

Among the above channels of IPO application, only the CCASS EIPO service provided by HKSCC is completely electronic for the applicants. White application form and yellow application form are paper-based, requiring the applicant or its intermediaries to fill in details in specified form for submission to the issuers through receiving banks. Successful applicants using white application form or eIPO will receive physical scrip. eIPO remains only sparingly used since its introduction in 2000.

6.2 The CCASS EIPO service offered by HKSCC is available to all CCASS Participants. CCASS Participants provide the application details via CCASS Terminal or PG to HKSCC. HKSCC will consolidate the applications, debit the application monies directly from the Participants' Designated Bank accounts electronically and forward the consolidated application details to the share registrars in the form of a computer data tape. The share registrars will provide the allotment results to HKSCC again in the form of a tape and deliver the issued certificates (in the name of HKSCC Nominees) to HKSCC. HKSCC will process the allotment tape and credit the allotted shares to the CCASS accounts of the relevant Participants. HKSCC will also inform the Participants of the allotment results via the reports and the screen enquiries in CCASS.

- 6.3 It is proposed that upon implementation of a scripless securities market, issuers would be free not to offer scrip at all. Whilst they will be allowed to also offer scrip during the initial phase, all new IPOs will be required to offer scripless shares. The IPO application process will remain largely the same except that there will be no need for share registrars to print certificates for the uncertificated shareholders.
- 6.4 For CCASS EIPO and the yellow application form, the allotment results will be uploaded to HKSCC via CCASS Terminal or PG instead of in the form of physical tape. Allotted shares will be credited by HKSCC to the CCASS Participants' accounts and will automatically be registered on the CCASS Register in the names of the CCASS Participants or the holders of the CCASS Participant Sponsored Accounts. The holders of the CCASS Participant Sponsored Accounts may apply through their sponsoring CCASS Participants.
- 6.5 Applications in the white application form and the yellow application form will remain unchanged, except that share registrars may no longer need to capture the signature specimen of applicants for scripless IPO. This will also simplify the eIPO process which as at present still requires the share registrars to obtain the applicants' signatures after the allotment of shares. According to past experience, post-allotment signature collection process often takes a long time to complete.
- 6.6 Post-scripless, applicants can use either the white application forms or eIPO if they want their shareholdings to be registered on the Issuer Register. The white application forms and eIPO will need to be changed to offer the choices of certificated and uncertificated holdings accordingly. Applicants can use yellow application forms or CCASS EIPO if they want their shareholdings registered on the CCASS Register. These applicants may choose their allotted shares to be held in (i) the disclosed IP Accounts; (ii) the CCASS Participant Sponsored Accounts; (iii) the non-disclosed client accounts under the CCASS Participants; or (iv) the non-disclosed IP Accounts under HKSCC Nominees. Applicants will have to become IPs before making the application should they choose to hold their shares in the disclosed IP Accounts or non-disclosed IP Accounts.

6.7 Hence, investors may subscribe to an IPO via the following channels post-scripless –

- White application form (allotted shares issued in their names on the Issuer Register);
- Yellow application form (allotted shares issued in the names of the CCASS Participants or the holders of the CCASS Participant Sponsored Accounts on the CCASS Register);
- CCASS EIPO (optional to the issuers and allotted shares issued in the names of the CCASS Participants or the holders of the CCASS Participant Sponsored Accounts on the CCASS Register); and
- eIPO (optional to the issuers and allotted shares issued in their names on the Issuer Register).

6.8 Appendix 6 provides a summary of the major changes under the scripless securities market model to the yellow application form and CCASS EIPO process for easy reference.

CHAPTER SEVEN

IMPLICATIONS OF THE SCRIPLESS SECURITIES MARKET MODEL FOR MARKET OPERATIONS

- 7.1 Implementation of the scripless securities market model as proposed in this paper will result in certain operational implications for market participants. This Chapter summarises the main operational implications for the different market operators and users.

Investors

- 7.2 Investors can choose to hold their uncertificated shares as registered shareholders in the following forms – IPs and holders of CCASS Participant Sponsored Accounts on the CCASS Register, and uncertificated shareholders on the Issuer Register. Certificated shares can only be held on the Issuer Register.
- 7.3 As IPs, they will continue to receive corporate communications directly from the share registrars and will receive the entitlements from HKSCC, both as at present. Subject to the review on IP Account services, IPs who do not wish to be on the register of members may choose to open non-disclosed IP Accounts held by HKSCC Nominees. The IP Account will be suitable for investors who wish to have better and direct control over their shareholdings. However, trading will still be via their brokers.
- 7.4 As the holders of the CCASS Participant Sponsored Accounts, the investors will entrust their shares to the CCASS Participants (other than IPs), as the holders of the Stock Segregated Accounts with Statement do at present. Unlike the present holders of the Stock Segregated Accounts with Statement, the names of the holders of the CCASS Participant Sponsored Accounts will be registered on the CCASS Register. The holders of CCASS Participant Sponsored Accounts would enjoy a higher level of protection as compared with the non-disclosed clients of the CCASS Participants because in the event of liquidation of the sponsoring CCASS Participant, the liquidator or the administrator should be readily able to distinguish their assets from those of the sponsoring CCASS Participant. Besides, the holders of the CCASS Participant Sponsored Accounts will be able to receive corporate communications directly from the share registrars. HKSCC will send statements to the holders of the

CCASS Participant Sponsored Accounts on both periodic and ad hoc bases (the latter when there are stock movements in their accounts).

- 7.5 The CCASS Participants as the sponsoring CCASS Participants will handle corporate actions and entitlements on behalf of the holders of CCASS Participant Sponsored Accounts. Under normal circumstances, the holders of the CCASS Participant Sponsored Accounts will only be able to remove or transfer their shares therein via their sponsoring CCASS Participants.
- 7.6 Alternatively, investors may register their uncertificated shares on the Issuer Register. They will receive the SRNs and the statements from the share registrars. However, for settlement of SEHK Trades, the investors must first deposit their shares to the accounts of the Broker Participants. The SRNs will have to be disclosed to the intermediaries for any movements of their uncertificated shareholdings from the Issuer Register. As such, to avoid misuse of the SRN and misappropriation of shares, the investors will need to adequately protect the SRN. The shareholders on the Issuer Register will, as at present, receive corporate communications from the share registrars and handle for themselves the corporate actions.
- 7.7 Post-scripless, it is proposed that the current immediate credit policy of HKSCC be removed due to technical and risk management reasons. Investors who want to sell their shares in scrip form may as a result have to deposit their shares into CCASS in advance, depending on how quickly the share registrars may complete the registration and/or scrip cancellation. Close co-ordination will be required between HKSCC and the share registrars in order to cut short the processing time. At present, the share registrars may complete a transfer request in a minimum of three days (at higher fees). The Federation of Share Registrars is considering if they can do it in future in shorter time, so that investors who deliver physical certificates to their brokers at the time of order placing will have their shares available for settlement in time.
- 7.8 Some brokers currently require the investors to deliver shares to them before order placing. The proposed processing of EDIs (deposits of uncertificated shares into CCASS) would mean that these investors would have to transfer their uncertificated shares on the Issuer Register by EDIs to their brokers' accounts in CCASS one day before they sell their shares.

7.9 For investors who want to deposit their certificated shareholdings through their brokers or custodians, they have to request the brokers or custodians to input dematerialisation requests into CCASS for them.

Issuers

7.10 At present, all companies incorporated in Hong Kong are required by the law to issue physical certificates to shareholders. Upon implementation of a scripless securities market, issuers need to offer scripless IPO while allowing them to also offer scrip during the initial phase.

7.11 The shares registered on the CCASS Register will no longer be registered in the name of HKSCC Nominees. As the identities of shareholders will become more transparent, issuers will be able to communicate with them and receive their instructions for corporate actions on a more timely basis. Share registrars will continue to handle the corporate communications and corporate actions for issuers, hence there will be no significant operational impact to them. However, if there are more names on the registers of members, issuers may incur more costs in respect of corporate communications.

CCASS Participants, mainly Brokers and Custodians

7.12 CCASS Participants will likely have to modify their back office systems to support the various features of scripless (such as SRN, new transaction types for inter-register transfers) but we believe such modifications should be relatively minor.

7.13 CCASS Participants may also have to modify their operations if they want to support the new shareholding options for investors, including in particular the CCASS Participant Sponsored Accounts and the uncertificated shareholdings on the Issuer Register. For investors who select the CCASS Participant Sponsored Accounts, the CCASS Participants (other than IPs) will be their sponsoring CCASS Participants. The sponsoring CCASS Participants will have to handle the account opening documents for the CCASS Participant Sponsored Accounts and will have full control over these accounts. The sponsoring CCASS Participant will also be responsible for moving shares from/to the CCASS Participant Sponsored Account by SATI, e.g. for trade settlement. The holders of the CCASS Participant Sponsored Accounts

will have no direct linkage with CCASS and the sponsoring CCASS Participants will have to handle all corporate activities and queries for their clients.

- 7.14 Brokers may in future have clients who choose to hold uncertificated shares on the Issuer Register. In order to execute a sell order on behalf of those clients, the Broker Participants will likely prefer to first transfer their shares from the Issuer Register by EDIs to their CCASS accounts. This would require their clients to inform the Broker Participants of the relevant SRNs. The Broker Participants (and likewise applicable to the Custodian Participants) will need to exercise prudent internal control to avoid any misuse of the SRNs.
- 7.15 For clients who want to dematerialise their certificated holdings or to rematerialise their uncertificated holdings, the Broker/Custodian Participants will input dematerialisation and rematerialisation requests for them. The processing of dematerialisation and rematerialisation is similar to that of the current deposit and withdrawal transactions.
- 7.16 Both Broker Participants and Custodian Participants will likely be affected by the proposal to remove the immediate credit policy after the implementation of scripless. We understand the proposal would inevitably create inconvenience to the market but we are also constrained by the technical problem arising from the scripless securities market model. We will further explore with market participants and the Federation of Share Registrars to see how such market impact might be minimised.

Share Registrars

- 7.17 Share registrars will have to produce the complete registers of members, consisting of the Issuer Register (maintained directly by the share registrars) and the CCASS Register (sent daily to the share registrars by HKSCC) for public inspection. Share registrars may either be admitted into CCASS under a new participantship which will provide the basis on which CCASS infrastructure will be extended to the share registrars or to enter into some form of arrangement with HKSCC.

- 7.18 Share registrars will maintain the registers of members and continue to provide corporate communications to all shareholders on the registers of members. They will handle corporate actions on behalf of the shareholders on the Issuer Register, and will distribute entitlements to them as well. There will be slight changes to the IPO process. To implement the proposed operational model, share registrars may have to modify their systems and operation procedures accordingly.
- 7.19 Under the proposed scripless securities market model, there will be uncertificated shareholders on the Issuer Register. Share registrars will have to mail statements and SRNs to these shareholders. Uncertificated shares can be electronically transferred between the Issuer Register and the CCASS Register by EDIs and EWIs. Share registrars will have to be connected to CCASS via the CCASS Network to facilitate these kinds of inter-register transfers. Share registrars will have to be able to comply with the technical and operational standards set by HKSCC to support the scripless securities market.
- 7.20 Moreover, share registrars will have to cater for dematerialisation and rematerialisation requests from shareholders, including those on the CCASS Register. They will have to validate, process and confirm the request files from CCASS.
- 7.21 Necessary enhancements to the systems of share registrars would likely be significant. Some smaller share registrars might not be prepared to make or might not be able to afford this investment. It is for the market to consider whether these smaller share registrars, if they so wish, should be given the option to deal with only scrip as at present, leaving the uncertificated shareholdings to HKSCC.

HKSCC

- 7.22 HKSCC will maintain a CCASS Register which records the shareholdings of the CCASS Participants. The proposed model will not affect the settlement mechanism. The completion of settlement of SEHK Trades and the registration at the CCASS Participant level will happen simultaneously and automatically after scripless.

- 7.23 HKSCC will provide a new account type – the CCASS Participant Sponsored Accounts in CCASS. The operation of the CCASS Participant Sponsored Accounts will be similar to that of the current Stock Segregated Accounts with Statement where the sponsoring CCASS Participants will have full control over these accounts and HKSCC will send statements to the account holders.
- 7.24 To facilitate the inter-register transfers after scripless, HKSCC will have to set up electronic linkages with the share registrars to facilitate the various types of transactions such as EDI, EWI, dematerialisation, rematerialisation and transmission of the day-end CCASS Register records.
- 7.25 In the post-settlement services, HKSCC will continue to provide value-added corporate action services to its Participants on the CCASS Register. As proposed in paragraph 5.4, HKSCC will explore the necessary arrangement with the SFC and the Federation of Share Registrars to enable it to continue to provide the corporate action services to its Participants post-scripless. In any case, HKSCC will continue to interact primarily with the share registrars for the provision of corporate action services to its Participants like today. In addition to the names registered on the CCASS Register, HKSCC will also provide the names of the clients of the CCASS Participants to the share registrars for distribution of corporate communications if these clients so elect through their intermediaries. For the implementation of the scripless securities market model, HKSCC will also have to modify its system, and the CCASS Rules and Operational Procedures.

CHAPTER EIGHT OTHER ISSUES

Shareholder Reference Number (“SRN”) and Protection for Investors

- 8.1 The SFC Consultation Paper proposes the concept of SRN used in the Australian market. Under that proposal, SRN will be issued and managed by the share registrars. For each uncertificated shareholding on the Issuer Register, an investor will be given a unique SRN. When the investor sells his or her shares, he or she will have to instruct his or her broker to transfer his or her shares from the Issuer Register to the CCASS Register by means of an EDI. The investor will need to provide his or her registered name and address as well as the relevant SRN to his or her broker as required for the EDI input. (For details of the processing of EDI, please refer to paragraph 3.36 above.)
- 8.2 In disclosing his or her SRN to a third party, the investor is exposed to possible risk of misappropriation. Investors therefore should carefully protect their SRNs from unintended disclosure. The brokers and custodians who have been entrusted by their clients with their SRNs also need to protect the information from unauthorised access or misuse. This would accordingly increase the responsibility, internal control, liabilities and workload of the brokers and the custodians. Should investors’ uncertificated shares by mistake or as a result of fraud be transferred from the Issuer Register to the CCASS Register and sold, the liabilities, if any, among the investors, the issuers, the share registrars, the market intermediaries and HKSCC would also need to be carefully and thoroughly considered.
- 8.3 The SRNs issued by the share registrars will likely be sent by mail to the registered shareholders. The mailing process is another source of risks to the investors as that mail will contain all necessary information to effect an EDI (including the name and address of the shareholder and his or her SRN). Such risks are particularly worrisome in the case of popular scripless IPOs (where a large number of mails containing SRNs will be sent to the shareholders around the same time).

- 8.4 In addition, SRN is issue-specific. An investor will receive from the share registrar(s) different SRNs in respect of different uncertificated shares he or she holds. This means that investors holding multiple shares will have to manage multiple SRNs. This could be improved in terms of shareholder-friendliness if share registrars were to allow shareholders to change their SRNs.
- 8.5 SRN is essentially a matter between the share registrars and the uncertificated shareholders outside CCASS, although CCASS might choose to encrypt the SRN when handling the information within CCASS. The SRN proposal is not perfect, however, the risks associated with it is arguably less than that associated with physical certificates. For other markets which adopt a similar scripless securities market model as currently proposed for Hong Kong, most of them have adopted or proposed to adopt the SRN. It is recognised that there is no obvious alternative which is user-friendly, operationally simple, secure and inexpensive. In the absence of such an alternative, issuers, share registrars and the SFC may collectively conduct an investor education programme to increase investors' awareness of the importance of adequately protecting their SRNs from unintended disclosure. SRN-related processes (such as mailing of SRNs to shareholders) will also need to be carefully handled. We would welcome comments on whether the proposal for using the SRN is acceptable, and if not, what the concerns are and are there any other means available to address the problems. We would pass comments received to the share registrars and the SFC for further consideration.

Dematerialisation Cost

- 8.6 We estimate that there are a total of about 25 million to 30 million certificates of listed securities in the market, six million of which are currently held in the CCASS Depository. Dematerialisation will be a labour-intensive process and will incur costs to the market. Most of these costs go directly to issuers, market operators and intermediaries, including HKSCC, share registrars, custodians (who are still maintaining vaults for physical scrip) and to a lesser extent brokers. While it may be possible to pass some of these costs on to investors and market users, most however may not be recoverable. Moreover, collecting a dematerialisation fee from investors will adversely affect their willingness to accept the scripless securities market model. It will require collective and joint efforts among the different parties to develop a scheme as to how to allocate these costs in the market.

Fees and Charges in the Scripless Securities Market

- 8.7 The implementation of the scripless securities market model will inevitably affect the operations and business model of HKSCC as well as other market participants. This may result in changes to their fee structures. It is beyond the scope of this Consultation Paper to consider issues relating to fees. However, we believe this issue will be dealt with through the normal operation of market forces and the established processes. Insofar as CCASS fees are concerned, a review would seem necessary. The review will on the one hand respond to changes to the business model and operations of HKSCC arising from the implementation of scripless securities market model, and aim to rationalise the existing fees on the other. Careful consideration will be given to this exercise in order not to increase the total costs of the market in Hong Kong.

CHAPTER NINE CONCLUSIONS

9.1 This Consultation Paper sets out the detailed operational model envisaged for the proposed scripless securities market. It is of relevance to CCASS Participants, other market intermediaries, share registrars, issuers and the investing public at large. The proposals contained herein are largely a result of discussions with the SFC, the share registrars and the market intermediaries. Reference, where applicable, has also been made to overseas markets which have already dematerialised or propose to move to a scripless environment.

9.2 HKEx welcomes comments on the contents of this Consultation Paper, particularly on the following aspects:–

In Chapter Three:–

- the complete register of members (reconciliation process of the CCASS Register and the Issuer Registers);
- the CCASS Register (name-on-register account types);
- the post-scripless HKSCC participanship structure;
- the processing of EDI, EWI, dematerialisation and rematerialisation;
- the clearing and settlement services (definition of settlement finality in CCASS); and
- the post-scripless CCASS infrastructure and processing schedule.

In Chapter Four:–

- the dematerialisation programme.

In Chapter Five:–

- the role of HKSCC in providing corporate action services to its Participants.

In Chapter Six:–

- the IPO process.

In Chapter Seven:–

- the implications of the scripless securities market model for market operations.

In Chapter Eight:–

- the design and application of the SRN;
- the dematerialisation costs; and
- the fees and charges in the scripless securities market.

9.3 HKEx will work closely with the SFC, the Federation of Share Registrars and other parties under the auspices of the IWG to finalise the CCASS operational model for the scripless securities market subject to the comments received. Some of the issues discussed herein are outside the prerogative of HKEx. HKEx will share the comments received with the relevant parties for their consideration.

9.4 It should be noted that the implementation of the scripless securities market model is subject to legislative amendments, which are being worked on by the Government and the SFC and, as noted in the SFC Consultation Conclusions, will be the subject of a separate consultation. HKEx will provide its input to the Government and the SFC.

9.5 The consultation period closes on Tuesday, 23 December 2003.
Comments should be made in writing by:

(i) mail to: Hong Kong Exchanges and Clearing Limited
7th Floor, Vicwood Plaza
199 Des Voeux Road Central
Hong Kong
Attention: The Scripless Project Team

(ii) fax to: (852) 2541 3234

(iii) e-mail to: scp@hkex.com.hk

GLOSSARY OF TERMS

Account Transfer Instructions (ATI)	means instructions of a Participant other than an Investor Participant to effect book-entry movements of Eligible Securities between different stock accounts of the Participant in CCASS;
Approved Share Registrar	means a registrar (or a listed company which serves as its own registrar) that is a member of the Federation of Share Registrars;
Broker Participant	means a Participant admitted to participate in CCASS as a Broker Participant;
CCASS	means the Central Clearing and Settlement System established and operated by HKSCC;
CCASS Depository	means one or more securities depositories for CCASS, providing safe-keeping facilities for Eligible Securities held in CCASS as well as to cater for withdrawals and deposits of Eligible Securities by CCASS Participants;
CCASS EIPO	means the arrangement for instructions to be given electronically to HKSCC by the Participants for applications to be made for shares issued under IPO;
CCASS Operational Procedures	means the Operational Procedures of HKSCC in relation to CCASS, containing the practices, procedures and administrative requirements relating to the operations and functions of CCASS, as from time to time in force;

CCASS Participants or Participants	means brokers, custodians, clearing agency, stock lenders, stock pledgees and investors admitted by HKSCC as participants under CCASS, enabling them to participate in the book-entry clearing and settlement system under CCASS;
CCASS Participant Sponsored Account	means an account in CCASS opened for an investor and sponsored by a CCASS Participant (other than an Investor Participant);
CCASS Register	means a register reflecting the holdings of CCASS Participants and the holders of CCASS Participant Sponsored Accounts, which when combined with the Issuer Register forms a complete register of members of an issuer;
CCASS Rules	means the General Rules of CCASS which set out the terms and conditions regulating the use of CCASS;
CCASS Terminal	means a terminal connected to the CCASS host computer of HKSCC, installed at the office of a CCASS Participant other than an Investor Participant and providing that Participant with direct electronic linkage to CCASS;
Clearing Agency Participant	means a Participant admitted to participate in CCASS as a Clearing Agency Participant;
Clearing Agency Transaction	means a transaction, other than an SI Transaction, between a Participant other than an Investor Participant and a Clearing Agency Participant for settlement in CCASS as referred to in the CCASS Rules;

Continuous Net Settlement (CNS)	means the system whereby all trades in a particular stock are continuously pooled to arrive at the smallest number of (net) deliveries at the end of the settlement day. Any overdue net positions are then carried over and to the extent possible, offset against the following day's net settlement positions;
Custodian Participant	means a Participant admitted to participate in CCASS as a Custodian Participant;
Delivery versus Payment (DVP)	means in relation to settlement of a stock position in CCASS by a Participant, the settlement of such a stock position in CCASS on the basis that settlement of the corresponding money position of such stock position will follow as part of the CCASS money settlement process;
Dematerialisation	means the process whereby a certificated shareholding is converted to an uncertificated shareholding;
Designated Bank	means, in relation to any Participant, any bank in Hong Kong designated by that Participant and approved by HKSCC for money settlement purposes;
Electronic Deposit Instruction (EDI)	means an instruction of a Participant to move Eligible Securities in uncertificated form from the Issuer Register to the CCASS Register;
eIPO	means the arrangement for instructions to be given electronically to the share registrar by the investor for applications to be made for shares issued under IPO;

Electronic Withdrawal Instruction (EWI)	means an instruction of a Participant to move Eligible Securities in uncertificated form from the CCASS Register to the Issuer Register;
Electronic Payment Instruction (EPI)	means a payment instruction generated by HKSCC and forwarded for processing to the Designated Bank of a Participant via the Clearing House of Hong Kong Association of Banks, in relation to (i) payment to be effected between two Participants following settlement of an Isolated Trade or an SI Transaction or an ISI Transaction in CCASS on a DVP basis or (ii) payment or refund of application monies in respect of CCASS EIPO applications via CCASS;
Eligible Security	means an issue of securities which is from time to time accepted as eligible by HKSCC for deposit, clearing and settlement in CCASS, in accordance with the CCASS Rules, and where the context so requires shall include any particular security or securities of such an issue;
Federation of Share Registrars	means the Federation of Share Registrars Limited approved by the SFC under the Securities and Futures (Stock Market Listing) Rules;
Free of Payment (FOP)	means, in relation to the settlement of a stock position in CCASS by a Participant, the settlement of such a stock position in CCASS which does not require the settlement of the corresponding money position of such stock position to be effected thereafter as part of the CCASS money settlement process (noting that money settlement may still take place outside CCASS);

HKEx	means the Hong Kong Exchanges and Clearing Limited;
HKSCC	means the Hong Kong Securities Clearing Company Limited, a wholly owned subsidiary of HKEx;
HKSCC Nominees	means the HKSCC Nominees Limited or such other nominee company as may be used by HKSCC from time to time in relation to the provision of nominee services to Participants;
Initial Public Offering (IPO)	means listing of securities on SEHK;
Investor Participant (IP)	means a person admitted to participate in CCASS as an Investor Participant who may be an individual or joint individuals or a corporation;
Investor Participant Accounts	means accounts opened by Investor Participants in CCASS;
Investor Settlement Instructions (ISI)	means instructions of an Investor Participant relating to transactions in Eligible Securities for non-SEHK Trades to be settled in CCASS;
ISI Transaction	means a transaction to be settled in CCASS between an Investor Participant and a Participant other than an Investor Participant as a result of the input of an Investor Settlement Instruction, authorized, if required, and affirmed by the Investor Participant concerned;

Isolated Trades (IT)	means, as the case may be, either, in relation to an SEHK Trade, a trade which is designated by the two counterparty Broker Participants concerned to be settled under the Isolated Trades System or, in relation to a Clearing Agency Transaction, a trade which is reported by a Clearing Agency Participant to be settled under the Isolated Trade System or, such other trade or transaction between Participants (including an SEHK trade and a Clearing Agency Transaction but excluding an SI Transaction) which is not accepted by HKSCC for settlement under the CNS system;
Isolated Trade System	means the method of settlement in CCASS between Participants in relation to Isolated Trades;
Issuer	means any company or other legal person any of whose securities are the subject of an application for listing or some of whose securities are already listed;
Issuer Register	means a register maintained by the share registrar for the company, which when combined with the CCASS Register forms a complete register of members of an issuer;
Interactive Voice Response System (IVRS)	means the CCASS Phone System operated by HKSCC for enabling Investor Participants to access CCASS in accordance with the CCASS Rules;
Participant Gateway (PG)	means, in relation to a Participant (other than an Investor Participant), an optional technical device installed at the premises of the Participant which provides communication interface with CCASS in respect of particular functions specified by HKSCC from time to time;

Realtime Delivery versus Payment (RDP)	means, in relation to settlement of a stock position in CCASS by a Participant, the settlement of such a stock position in CCASS immediately following the settlement of the corresponding money position of such stock position by the Clearing House of the Hong Kong Association of Banks;
Register of Members (ROM)	means a register, held in a book, ledger card or computer print form, which contains details of the shareholders of a company and their shareholdings;
Registrar Participant	means an Approved Share Registrar to be admitted as a Participant into CCASS under the proposed scripless securities market model;
Rematerialisation	means the process whereby an uncertificated shareholding is converted into a certificated shareholding;
SCEFI	means the Steering Committee on the Enhancement of the Financial Infrastructure formed by the Financial Secretary in 1999;
SEHK	means the Stock Exchange of Hong Kong Limited, a wholly owned subsidiary of HKEx;
SEHK Trade	means a trade in an Eligible Security between two Broker Participants effected on or reported to SEHK;
SEOCH	means the SEHK Options Clearing House Limited, a wholly owned subsidiary of HKEx;
Settlement Instructions (SI)	means instructions of a Participant (other than an Investor Participant) relating to transactions in Eligible Securities for non-SEHK Trades to be settled in CCASS;

SI Transaction	means a transaction to be settled in CCASS between two Participants other than Investor Participants as a result of the input of a Settlement Instruction, authorized, if required, by each Participant (such Settlement Instructions being matched in CCASS);
Shareholder Reference Number (SRN)	means a number to be issued by the share registrar to the registered shareholders in relation to each of his or her uncertificated shareholdings on the Issuer Registers;
Share Registrar	means a person appointed by a listed company for the purpose of maintaining its register of members;
SFC	means the Securities and Futures Commission;
Sponsored Account Transfer Instructions (SATI)	means instructions input by the sponsoring CCASS Participants to transfer shares from the accounts of the sponsoring CCASS Participants to the CCASS Participant Sponsored Accounts and vice versa;
Stock Lender Participant	means a Participant admitted to participate in CCASS as a Stock Lender Participant;
Stock Pledgee Participant	means a Participant admitted to participate in CCASS as a Stock Pledgee Participant;
Stock Segregated Accounts with Statement	means stock accounts in CCASS offered by HKSCC to enable investors to reconcile their stockholdings and trading records kept by their brokers or custodians with statements issued by HKSCC;
T+1	means the first settlement day following the day of the transaction as reported by SEHK; and
T+2	means the second settlement day following the day of the transaction as reported by SEHK.

LIST OF DIAGRAMS

Diagram 1-1	Shares Deposited into the CCASS Depository to Market Total
Diagram 3-1	The Proposed Scripless Securities Market Model
Diagram 3-2	Post-scripless Physical Deposits into the CCASS Depository
Diagram 3-3	Process Flow of an Electronic Deposit Instruction
Diagram 3-4	Process Flow of an Electronic Withdrawal Instruction
Diagram 3-5	Dematerialisation at the Share Registrars
Diagram 3-6	Processing of a CCASS Rematerialisation Request
Diagram 3-7	Post-scripless CCASS Infrastructure
Diagram 4-1	Dematerialisation – Progressive Approach

APPENDIX 1
HKE_x STATEMENTS OF
POLICY ON PERSONAL DATA

PERSONAL INFORMATION COLLECTION STATEMENT

This Personal Information Collection Statement (“PICS”) is made in accordance with the guidelines issued by the Privacy Commissioner of Personal Data. The PICS sets out the purposes for which the Personal Data of respondents will be used after collection, what these respondents are agreeing to in respect of the Hong Kong Exchanges and Clearing Limited’s (“HKEx”) use of their Personal Data and their rights under the Personal Data (Privacy) Ordinance.

Purpose of Collection

HKEx may use the Personal Data of respondents collected by HKEx in connection with this Consultation Paper for one or more of the following purposes:

- for performing HKEx’s functions and those of its subsidiaries under the relevant laws, rules and regulations
- for research and statistical purposes
- for any other lawful purposes

Transfer of Personal Data

Personal Data collected may be disclosed by HKEx to members of the public in Hong Kong and elsewhere, as part of the public consultation on this Consultation Paper.

Access to or Correction of Data

You have the right to request access to and correction of your Personal Data in accordance with the provisions of the Personal Data (Privacy) Ordinance.

If you wish to request access to and/or correction of your Personal Data provided in your submission on this Consultation Paper, you may do so in writing addressed to:

Personal Data Privacy Officer
Hong Kong Exchanges and Clearing Limited
7th Floor, Vicwood Plaza
199 Des Voeux Road Central
Hong Kong
or
scp@hkex.com.hk

HKEx has the right to charge a reasonable fee for processing any data access request.

PRIVACY POLICY STATEMENT

HKEx is firmly committed to preserving the privacy of respondents in relation to Personal Data supplied to HKEx on a voluntary basis. Personal Data may include names, addresses, e-mail addresses, login names etc. HKEx uses the information for the stated purposes when your Personal Data is collected. The Personal Data will not be used for any other purposes without your consent unless such use is permitted or required by law.

HKEx has security measures in place to protect the loss, misuse and alteration of the Personal Data of respondents. HKEx will strive to maintain Personal Data as accurately as reasonably possible and Personal Data will be retained for such period as may be necessary for the proper discharge of the function of HKEx and those of its subsidiaries.

APPENDIX 2
RECONCILIATION OF THE RECORD
OF INTER-REGISTER TRANSFERS

Transactions made during the day:–

A. Between the CCASS Register and the Issuer Register

1. Shareholder A transfers 100 shares to Broker B
2. Broker C transfers 200 shares to Shareholder D

B. Within the CCASS Register

3. Broker B transfers 500 shares to Custodian F

C. Within the Issuer Register

4. Shareholder G transfers 100 shares to Shareholder A

CCASS Register				Issuer Register			
Shareholder	Open record	Day-end record	To reconcile the record	Shareholder	Open record	Day-end record	To reconcile the record
Broker B	5,000	+ 100 – 500 = 4,600		Shareholder A	200	– 100 + 100 = 200	
Broker C	200	– 200 = 0		Shareholder D	0	+ 200 = 200	
Broker E	1,000	= 1,000		Shareholder G	500	– 100 = 400	
Custodian F	0	+ 500 = 500					
Total	6,200	6,100	In + 100 Out – 200 = Out – 100	Total	700	800	In + 200 Out – 100 = In + 100

APPENDIX 3A
AN OVERVIEW OF POST-SCRIPTLESS
CCASS TRANSACTION TYPES

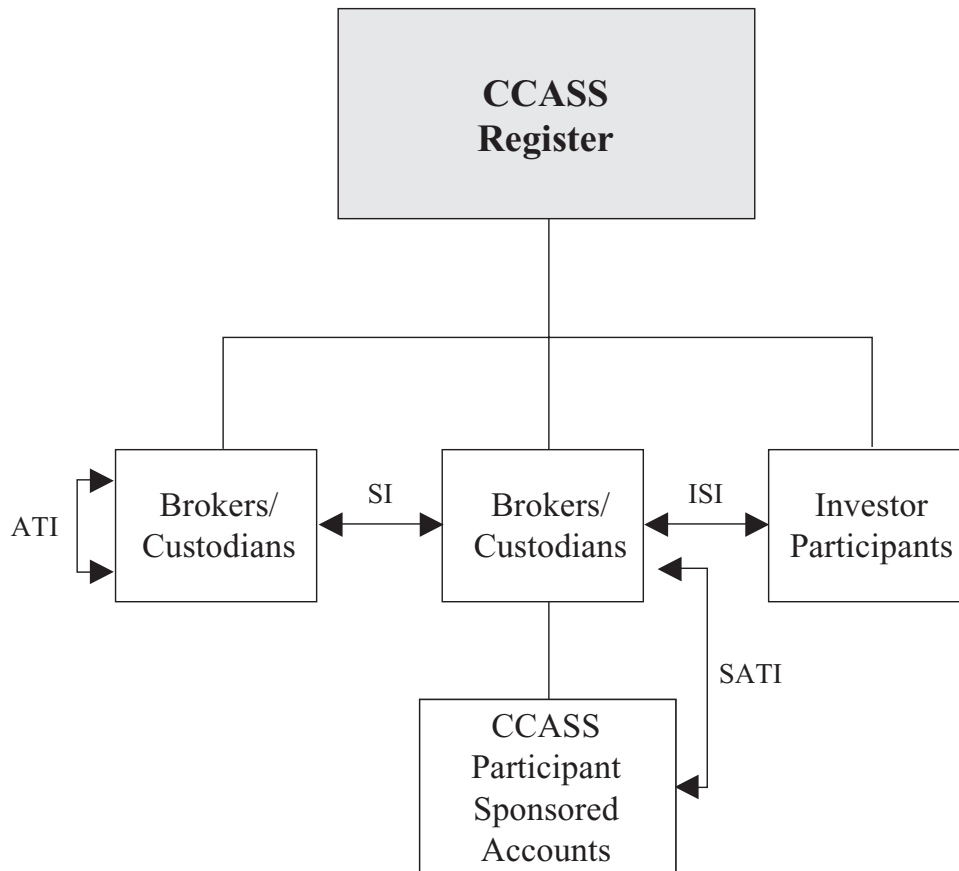

ATI: Account Transfer Instruction
ISI: Investor Settlement Instruction
SATI: Sponsored Account Transfer Instruction
SI: Settlement Instruction

APPENDIX 3B
AN OVERVIEW OF POST-SCRIPTLESS
SHARE REGISTRAR TRANSACTION TYPES

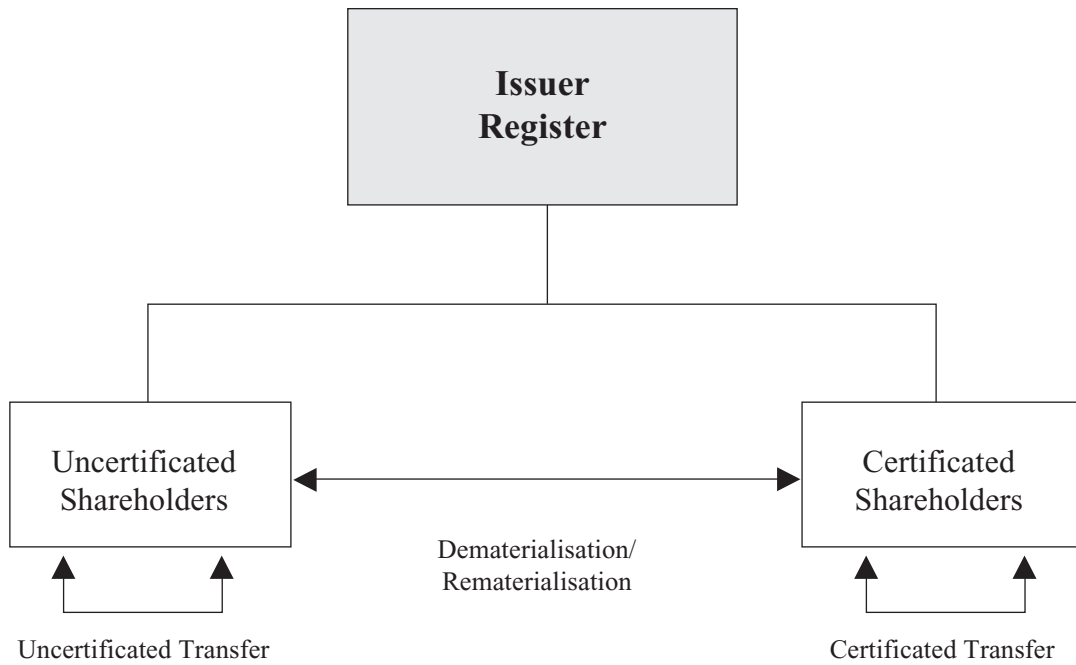

APPENDIX 3C
AN OVERVIEW OF POST-SCRIPTLESS
TRANSACTION TYPES BETWEEN
CCASS AND SHARE REGISTRARS

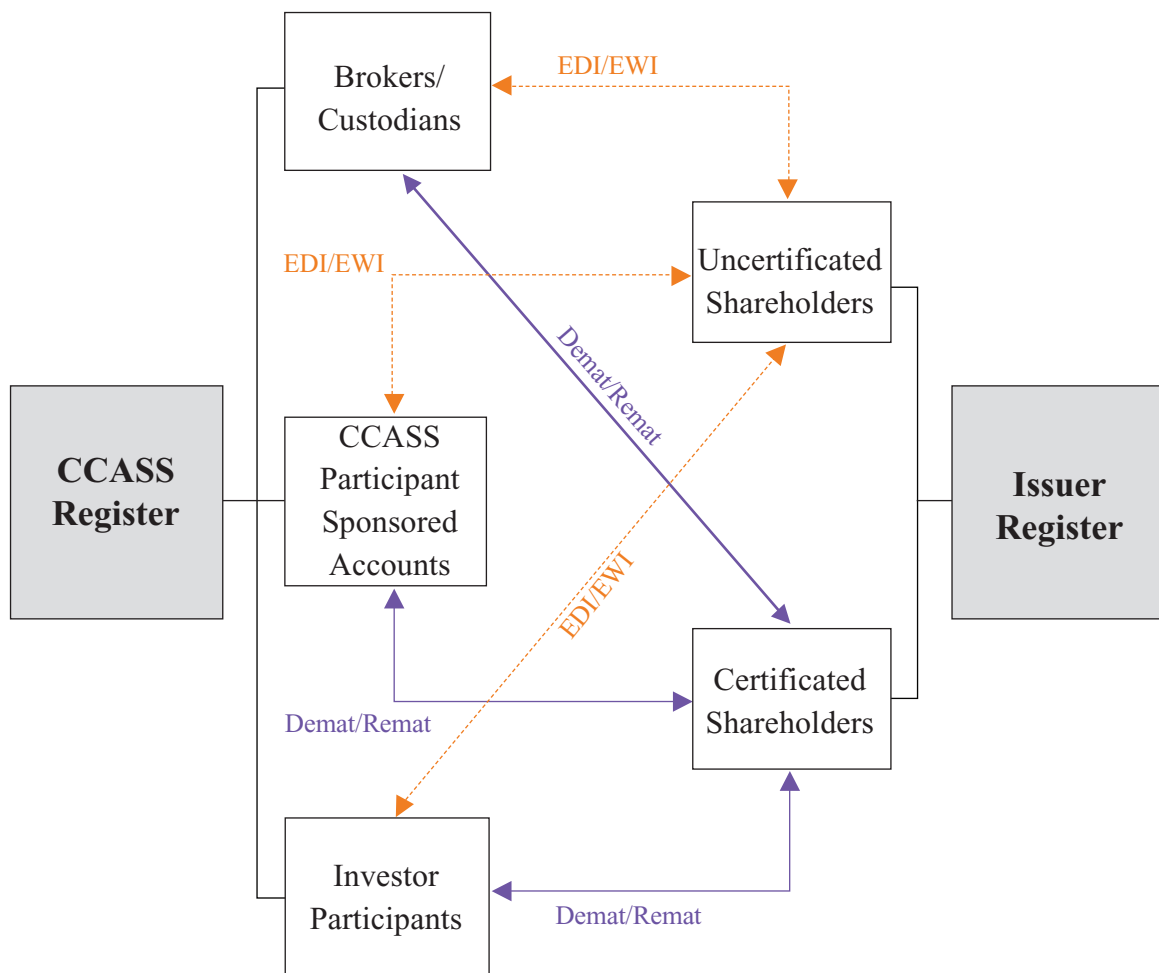

Demat/Remat: Dematerialisation/Rematerialisation
 EDI: Electronic Deposit Instruction
 EWI: Electronic Withdrawal Instruction

APPENDIX 5

DAY-END INTERACTIONS BETWEEN CCASS AND SHARE REGISTRARS' SYSTEMS

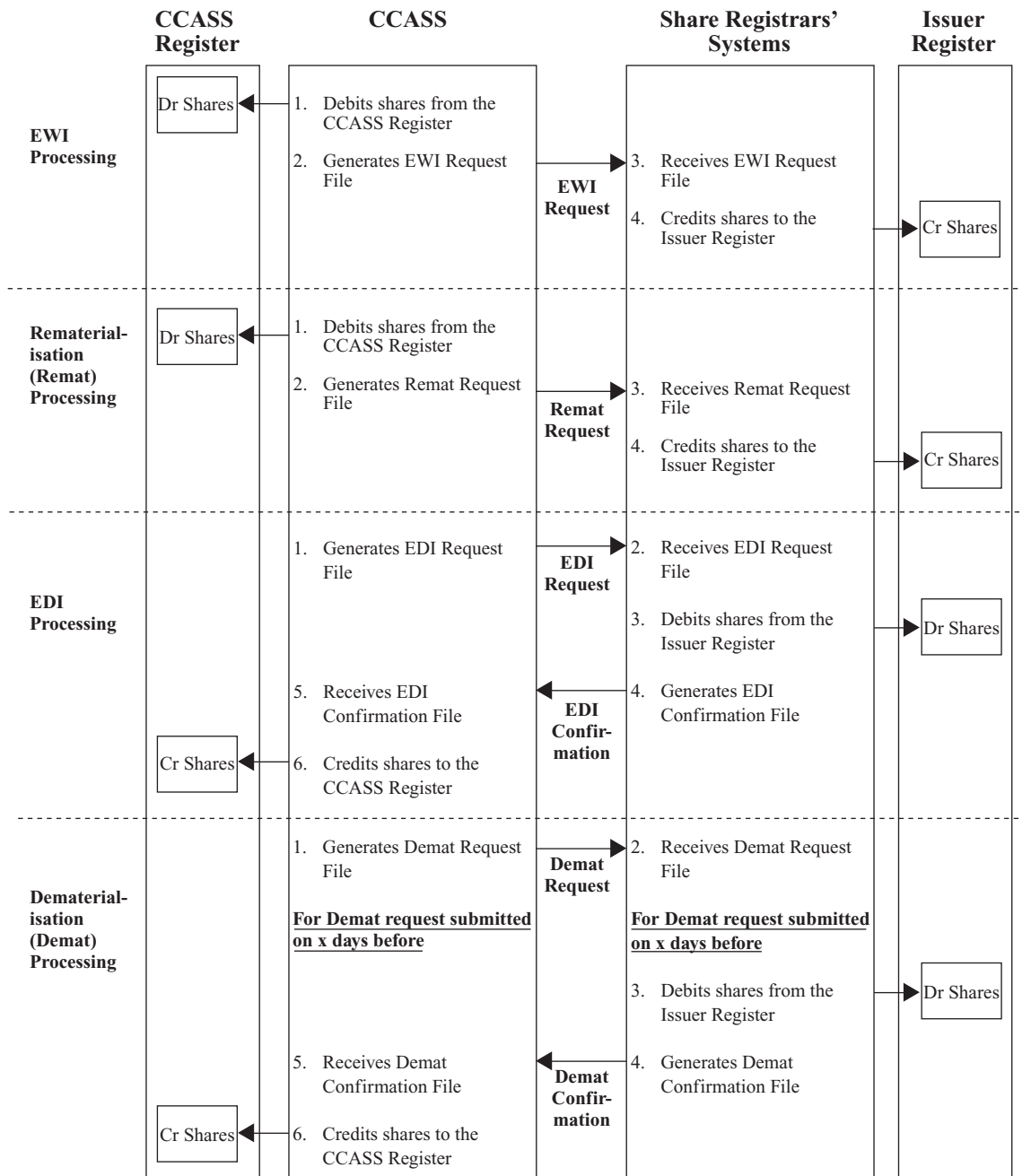

APPENDIX 6
SUMMARY OF THE MAJOR CHANGES
TO THE IPO PROCESS
(FOR YELLOW APPLICATION FORM
AND CCASS EIPO) UNDER
THE SCRIPLESS SECURITIES MARKET MODEL

Stage	Current Process	Changes due to scripless
Announcement	Issuer publishes announcement on newspapers. If the issuer elects to use CCASS EIPO, HKSCC sets up CCASS EIPO announcement in CCASS.	No changes.
Application	Sponsors and receiving banks distribute prospectuses and application forms.	No changes.
	<p>Investors submit cheques together with the yellow application forms to the receiving banks. Yellow form applications need to be endorsed by the CCASS Participants (optional for IPs but they need to fill in their IP Account numbers).</p> <p>For CCASS EIPO, the CCASS Participants submit applications to HKSCC.</p>	<p>Holders of the CCASS Participant Sponsored Accounts will use yellow application forms to submit IPO applications.</p> <p>For CCASS EIPO, the sponsoring CCASS Participants will input applications for the holders of the CCASS Participant Sponsored Accounts.</p>
Closing	<p>Receiving banks deliver application forms to the share registrar and send cheques for clearing. The share registrar inputs application information into its system and rejects multiple applications.</p> <p>For CCASS EIPO, HKSCC sends applications to the share registrar and sends Electronic Payment Instructions (“EPis”) to collect the application monies. The share registrar inputs application information into its system and rejects multiple applications.</p>	No changes.

Stage	Current Process	Changes due to scripless
Returned cheque/ rejected EPI processing	<p>Receiving banks collect returned cheque information from the Hong Kong Interbank Clearing Limited and inform the share registrar. The share registrar rejects applications related to the returned cheques.</p> <p>Similarly, for CCASS EIPO, receiving banks collect rejected EPI information and inform the share registrar. The share registrar rejects applications related to the rejected EPI.</p>	No changes.
Balloting and announcement of balloting results	<p>The share registrar processes balloting, confirms results with the sponsor and publishes balloting results on newspapers.</p> <p>For CCASS EIPO, HKSCC announces balloting results via reports and enquiry screens.</p>	Participants will enquire the application results of the holders of the CCASS Participant Sponsored Accounts via CCASS reports and screens.
Deliver certificates to HKSCC	The share registrar prints certificates and delivers them together with the allotment tape to HKSCC.	The share registrar will upload allotment file to HKSCC. No certificates will be printed.
	HKSCC processes the allotment tape and credits shares to the CCASS Participants' accounts and informs the Participants via reports and enquiry screens.	Participants will be able to enquire the application results of the holders of the CCASS Participant Sponsored Accounts via CCASS reports and screens.
Reconciliation	HKSCC validates the allotment tape.	HKSCC will reconcile the total number of shareholdings on the CCASS Register with the respective share registrar during the regular day-end processing.
Refund	<p>The share registrar prints refund cheques and delivers them to applicants via mail or counter.</p> <p>For CCASS EIPO, HKSCC informs the Participants via reports and enquiry screen and sends EPI to refund the application monies.</p>	Participants can obtain the application results of the holders of the CCASS Participant Sponsored Accounts from CCASS reports and screens.